



FIREYE® BurnerPRO™

MICROPROCESSOR-BASED INTEGRATED BURNER MANAGEMENT CONTROL



DESCRIPTION

The Fireye BurnerPRO is a compact, microprocessor based, primary flame safeguard control system designed to provide the proper burner sequencing, ignition and continuous flame monitoring for on-off, multi-stage, or modulating burners used in commercial heating and process equipment firing oil and gas fuels. The system is designed for use in non-permanent operations that requires burner recycle at least once every 24 hours.

Flame monitoring for the UV version is accomplished by the built in amplifier and compatible UV scanner. Control functions and timings are factory set via unique micro controller firmware. Through seven SMART LEDs, the control provides current operating status and lockout information in the event of a safety shutdown. Refer to the BurnerPRO ordering information section later in this document for the various combinations of control functions and timings.

A complete BurnerPRO system includes the BP110/230, flame scanner and wiring base. The BurnerPRO performs a safety self-test on every start. If a flame is detected prior to a start or during the purge cycle, the fuel valves are not energized and the control locks out. The LEDs and alarm terminal is used to annunciate the presence of a lockout condition.

Additional functions of the BurnerPRO include:

- Non-volatile lockout capability
- Proof of fuel valve closure
- Air-flow proving
- A run/check feature allows the operator to stop the program sequence in different positions (Purge, Ignition, PTFI and MTFI)
- Remote and local Reset
- One second flame failure response time
- Smart LEDs provide on board diagnostic lockout information
- Real-time internal diagnostics for added safety integrity
- Extended temperature operation (-40°C to 60°C) with an over-temp inhibit feature
- High capacity relay contacts



TABLE OF CONTENTS

BURNERPRO SPECIFICATIONS	3
PART NUMBERS AND APPROVALS	5
ORDERING INFORMATION	6
INSTALLATION PROCEDURE	8
WIRING BASE	8
TERMINAL WIRING	9
LED INDICATOR LIGHTS	11
LED RUN-TIME STATUS INDICATOR	12
FLAME SCANNERS	13
INSTALLATION - UV SCANNERS	13
WIRING - UV SCANNERS	15
SYSTEM OPERATION	15
OPERATIONAL SEQUENCE DIAGRAM	16
EXPLANATION OF SEQUENCE STATES	17
SEQUENCE TIMING	19
WIRING DIAGRAM FOR BURNER W/DIRECT IGNITION	21
WIRING DIAGRAM FOR BURNER W/INTERMITTENT PILOT	22
WIRING DIAGRAM FOR BURNER W/INTERRUPTED PILOT	23
DESCRIPTION OF FUNCTIONS OF OPERATING CONTROLS	24
LOCKOUTS	26
LOCKOUT CODES	27
LOCKOUT CODE EXPLANATION	29



WARNING: The equipment described in this manual is capable of causing property damage, severe injury, or death. It is the responsibility of the owner or user to ensure that the equipment described is installed, operated and commissioned in compliance with the requirements of all national and local codes.



WARNING!!!



Boiler operation, maintenance, and troubleshooting shall only be conducted by trained personnel. Persons troubleshooting lockouts or resetting the control must respond properly to troubleshooting error codes as described in this product bulletin.

Jumpers being used to perform static test on the system must only be used in a controlled manner and must be removed prior to the operation of the control. Such tests may verify the external controllers, limits, interlocks, actuators, valves, transformers, motors and other devices are operating properly. Such tests must be conducted with manual fuel valves in the closed position only. Replace all limits and interlocks not operating properly, and do not bypass limits in interlocks. Failure to follow these guidelines may result in an unsafe condition hazardous to life and property.



BURNERPRO SYSTEM SPECIFICATION

Supply Voltage:

BP110 110 VAC (+20%, -15%) 50/60 Hz, single phase

BP230 230 VAC (+10%, -15%) 50/60 Hz, single phase

Power Consumption:

7 VA

Temperature Rating:

Operating: -40°C to +60°C (-40°F to 140°F)

Storage: -50°C to +85°C (-58°F to 185°F)

Protection Category:

IP40 standard version (with exception of wiring base)

IP44 for "F" version

Control Dimensions:

With wiring base (60-2944-1); 4.15" L x 4.15" W x 5.0" H (105mm x 105mm x 127mm)

Shipping Weight:

Approx. 2.5 lbs. (1.13kg)

OPERATING TEMPERATURE LIMITS

CONTROL	MAXIMUM		MINIMUM	
	°F	°C	°F	°C
BP110, BP230	140°F	60°C	-40°F	-40°C
UV90L-1	194°F	90°C	-40°F	-40°C
UV1AL-3, -6	200°F	94°C	-40°F	-40°C
UV5-1	140°F	60°C	-4°F	-20°C

Relative Humidity:

90% R.H. (Non-Condensing)

LOAD RATINGS:

Terminal	Typical Load	Maximum Rating @120V-50/60 Hz	Maximum Rating @230V-50/60 Hz	Alternate Rating
6-7	Burner/Blower Motor	4 F.L.A. * 24 L.R.A.	4 F.L.A. * 24 L.R.A.	480 VA Pilot Duty (Motor Starter Coil)
9-10-11-20	Modulator	240 VA Pilot Duty		
16-17-18-19	Fuel/Igniton	240 VA Pilot Duty		
3	Alarm	125 VA Pilot Duty		
* F.L.A. = full load amps; L.R.A = locked rotor amps				

Maximum connected load must not exceed 2000VA.

ELECTRICAL RATINGS

VA ratings (not specified as pilot duty) permit the connection of transformers and similar devices whose inrush current is approximately the same as their running current.

VA Pilot Duty ratings permit the connection of relays, solenoid valves, lamps, etc. whose total operating load does not exceed the published rating and whose total inrush does not exceed 10 times the rating.



Running and locked rotor ratings are intended for motors. VA and VA Pilot Duty loads may be added to a motor load provided the total load does not exceed the published rating.

OPERATIONAL TIMINGS

The BurnerPRO is pre-programmed from the factory with a set of operational timings necessary for the safe operation of the burner system. The operational timings are governed by regional and local codes. It is important that the appropriate operational timing is selected for the burner application.

Table 1:

Times are in seconds		BURNERPRO SERIES (50Hz)			
TIMING	DESCRIPTION	S1	S2	S3	S6
t1	Purge time	36	31	37	30
t3'	Pre-ignition time (piloted)	4	6	2.5	0
TSA'	Ignition safety time (PTFI)	2	3	5.0	10
t6	Postpurge time	12	17	15	15
t9	Interval between Main Fuel Piloted and removal of Pilot (MTFI)	2	3	5	10
FFRT	Flame Failure Response Time (FFRT)	1.0			4.0

Times are in seconds		BURNERPRO SERIES (60Hz)			
TIMING	DESCRIPTION	S1	S2	S3	S6
t1	Purge time	30	25.8	30.8	30
t3'	Pre-ignition time (piloted)	3.3	5	2.1	0
TSA'	Ignition safety time (PTFI)	2.0	2.5	4.2	10
t6	Postpurge time	10	14.2	12.5	15
t9	Interval between Main fuel piloted and removal of pilot (MTFI)	1.7	2.5	4.2	10
FFRT	Flame Failure Response Time (FFRT)	1.0			4.0





See Table 7 on page 20 for expanded timing information.



NOTICE: This equipment generates and can radiate radio frequency energy, and if not installed and used in accordance with the instruction manual may cause interference to radio communications. It has been tested and found to comply with the limits for a Class B computing device pursuant to Subpart J of part 15 of FCC Rules, which are designed to provide reasonable protection against such interference when operated in a commercial/ industrial environment.

PART NUMBERS AND APPROVALS

Table 2: Agency Approvals

Fireye Part Number				
Control				
BP110UV-S1	X			
BP110UV-S2	X			
BP110UV-S3	X			
BP110UV-S6	X			
BP110UVF-S1	X			
BP110UVF-S2	X			
BP110UVF-S3	X			
BP110UVF-S6	X			
BP230UV-S1				
BP230UV-S2				
BP230UV-S3				
BP230UVF-S1				
BP230UVF-S2				
BP230UVF-S3				
Wiring Base				
60-2944-1	X	X		
Scanners				
UV90L-1	X	X		
UV1AL-3	X	X		
UV1AL-6	X	X		
UV5-1	X	X		

X = CERTIFICATION IN HAND

APPROVAL/CERTIFICATION

UL: MCCZ File MP1537 Controls, Primary Safety - Listed
MCCZ7 File MP1537 Controls, Primary Safety Certified for Canada



Table 3: ORDERING INFORMATION:

Item	Part Number	Description
1	BP230UV-S1	BurnerPRO Single Burner Control, 230VAC 50/60Hz, Series 1 timings, with UV non-self check amplifier
2	BP230UVF-S1	BurnerPRO Single Burner Control, 230VAC 50/60Hz, Series 1 timings, with UV non-self check amplifier, IP44 (Recommended for new installations - Contact Factory)
3	BP230UV-S2	BurnerPRO Single Burner Control, 230VAC 50/60Hz, Series 2 timings, with UV non-self check amplifier
4	BP230UVF-S2	BurnerPRO Single Burner Control, 230VAC 50/60Hz, Series 2 timings, with UV non-self check amplifier, IP44 (Recommended for new installations - Contact Factory)
5	BP230UV-S3	BurnerPRO Single Burner Control, 230VAC 50/60Hz, Series 3 timings, with UV non-self check amplifier
6	BP230UVF-S3	BurnerPRO Single Burner Control, 230VAC 50/60Hz, Series 3 timings, with UV non-self check amplifier, IP44 (Recommended for new installations - Contact Factory)
7	BP110UV-S1	BurnerPRO Single Burner Control, 110VAC 50/60Hz, Series 1 timings, with UV non-self check amplifier
8	BP110UVF-S1	BurnerPRO Single Burner Control, 110VAC 50/60Hz, Series 1 timings, with UV non-self check amplifier, IP44 (Recommended for new installations - Contact Factory)
9	BP110UV-S2	BurnerPRO Single Burner Control, 110VAC 50/60Hz, Series 2 timings, with UV non-self check amplifier
10	BP110UVF-S2	BurnerPRO Single Burner Control, 110VAC 50/60Hz, Series 2 timings, with UV non-self check amplifier, IP44 (Recommended for new installations - Contact Factory)
11	BP110UV-S3	BurnerPRO Single Burner Control, 110VAC 50/60Hz, Series 3 timings, with UV non-self check amplifier
12	BP110UVF-S3	BurnerPRO Single Burner Control, 110VAC 50/60Hz, Series 3 timings, with UV non-self check amplifier, IP44 (Recommended for new installations - Contact Factory)
13	BP110UV-S6	BurnerPRO Single Burner Control, 110VAC 50/60Hz, Series 6 timings, with UV non-self check amplifier
14	BP110UVF-S6	BurnerPRO Single Burner Control, 110VAC 50/60Hz, Series 6 timings, with UV non-self check amplifier, IP44 (Recommended for new installations - Contact Factory)

"F" in the part number field represents Fireeye version and it's recommended for new installations

BurnerPRO Wiring Base	
60-2981-1	Standard base with terminal block and knockouts, 4.2"L x 4.2"W x 1.22"H
60-2944-1 (for "F" series only)	Special base with terminal block and knockouts, 4.2"L x 4.2"W x 1.22"H
61-7429-1	Grounding wire/leash, 10" length

SCANNER SELECTION

FIREYE P/N	DESCRIPTION	BULLETIN
UV90L-1	UV scanner, Front and side (90°) lateral view, terminal block hook-up	SC-108
UV1AL-3, -6	UV scanner, 1/2" NPT connector, front view, 3ft/6ft cable, shielded leads	SC-108
4-742-1	Replacement UV tube for UV90L-1	
UV5-1	UV Scanner, front and side viewing, 6.5ft leads	SC-108

FIGURE 1.

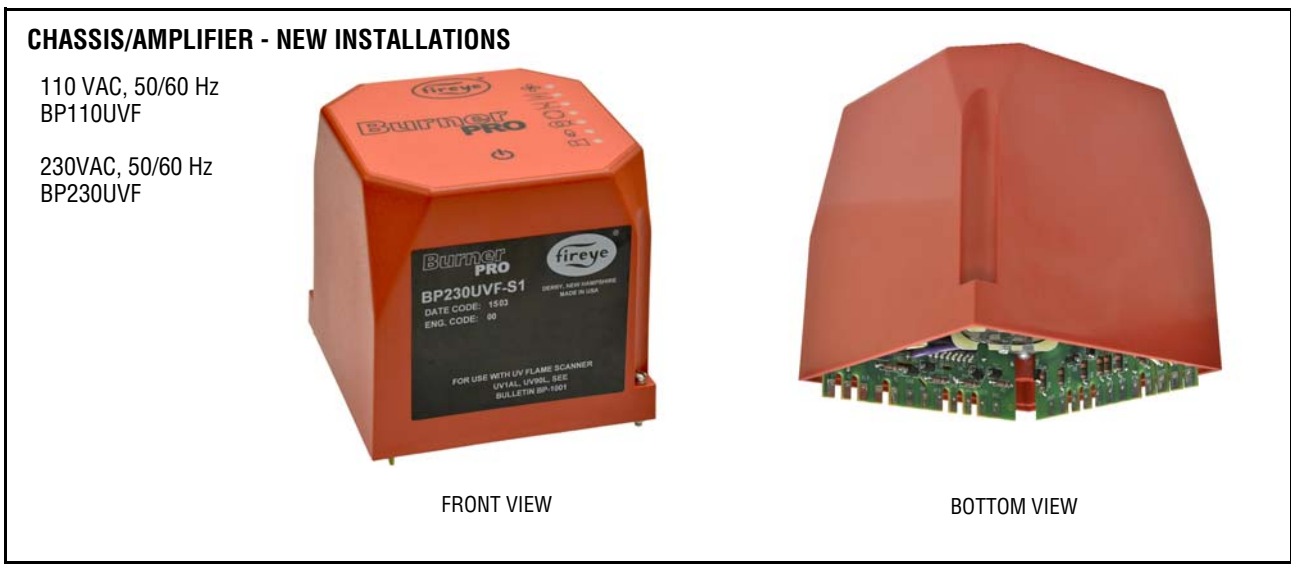
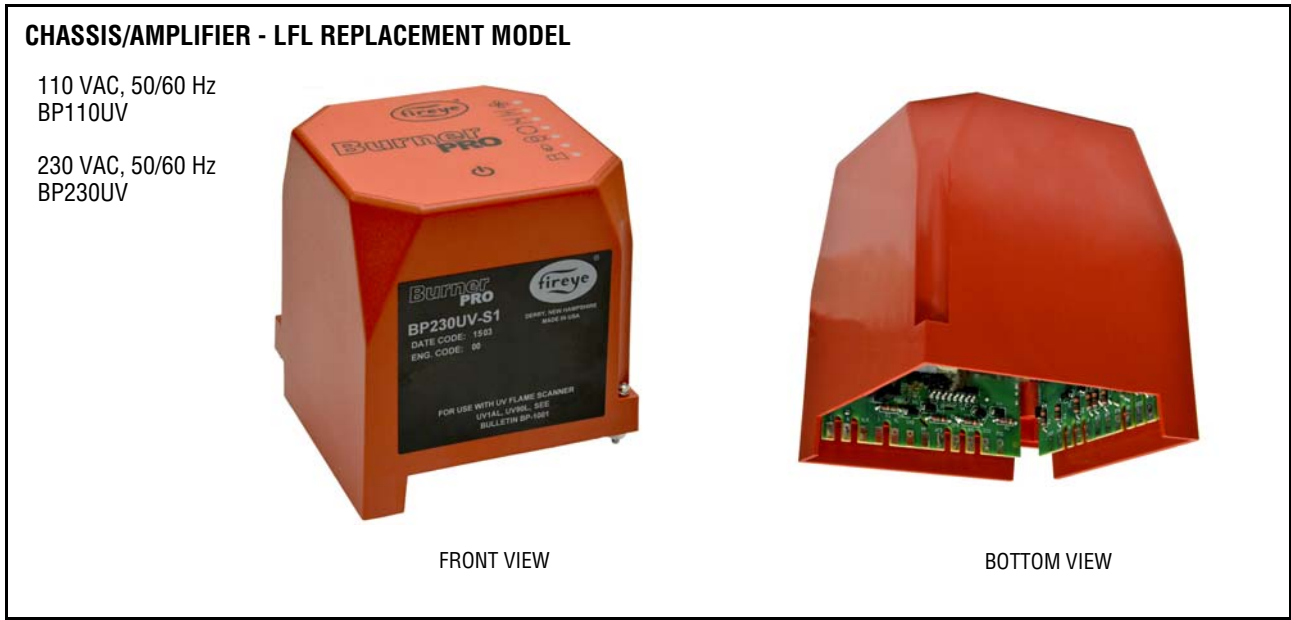

“F” in the part number field represents Fireye version and it's recommended for new installations



INSTALLATION PROCEDURE

Wiring Base

Mounting of the base can be accomplished with 2 screws. The recommended screw sizes are #10 PAN HD x 5/8inch (5mm PAN HD x 16mm) and #10 PAN HD x 3/8 inch (5mm PAN HD x 10mm). Refer to Figure 2 for mounting dimensions.

Grounding Wire

Each BurnerPRO control is fitted with a grounding wire. Attach the open end of the grounding wire to a ground terminal on the wiring base (see figure 2 below). Undo the screw terminal with a screwdriver and place the ground lug over the terminal. Re-install the screw over the ground lug. Do not attach the grounding wire to a Neutral (N) terminal.

FIGURE 2.

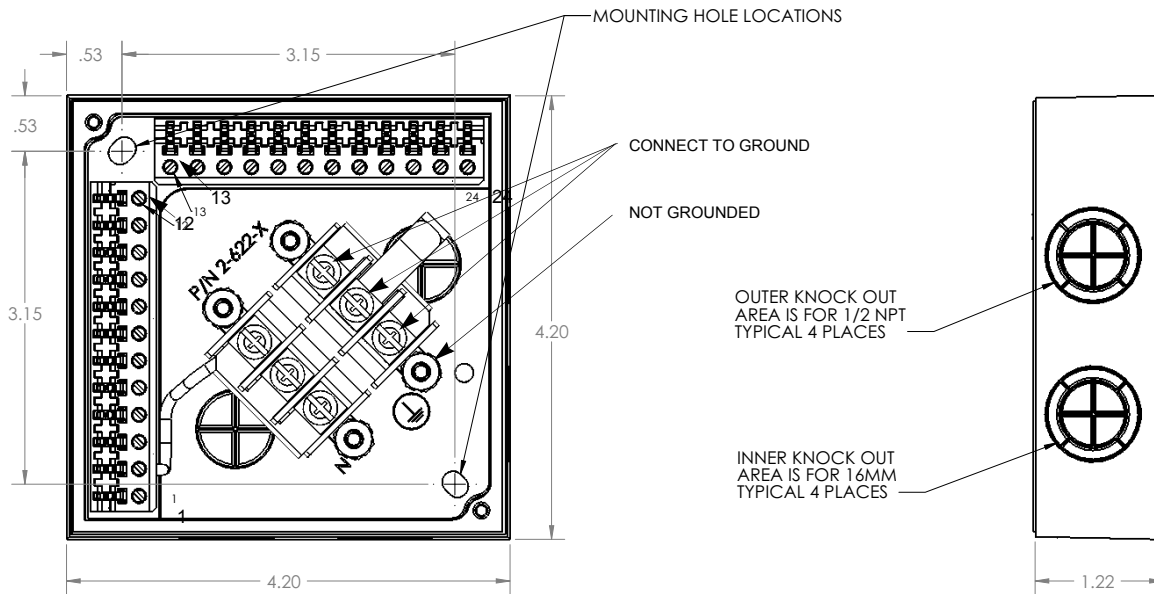

Note: The location should be free from excessive vibration and within the ambient temperature rating.



NOTICE: Installation, setup, and commissioning of the BurnerPRO control must be done by authorized and trained personnel. The personnel must know the do's and don'ts of the particular burner and must have relevant experience in the theories and practices of combustion control. Fireye cannot accept any liability for any consequences resulting from inappropriate, negligent or incorrect installation, commissioning or adjustment of operating parameters of the equipment. BurnerPRO does not have any user serviceable parts. If the unit has a problem, return the unit to your local distributor, or contact Fireye directly.

Table 4: TERMINAL WIRING

Terminal No.	Type	Description	Rating
1	Power	Line voltage supply	110VAC (+20%, -15%), 50/60Hz 230VAC (+10%, -15%), 50/60Hz single phase
2	Power	Line voltage common	
3	Output	Alarm	See Load Ratings
4	Output	Lockout Limits	110/230 VAC, 1mA
5	Input	Recycle Limits	110/230 VAC, 1mA
6	Output	Combustion Air Blower	See Load Ratings
7	Output	Combustion Air Blower	
8	Input	Actuator Feedback	110/230 VAC, 1mA
9	Output	High Fire Purge (Open)	See Load Ratings
10	Output	Low Fire Purge (Minimum)	See Load Ratings
11	Output	Closed (Economy)	See Load Ratings
12	Input	Proof of Closure (FVES)	110/230 VAC, 1mA
13	Input	Combustion Air Switch Test	110/230 VAC, 1mA
14	Input	Combustion Air Prove	110/230 VAC, 1mA
15	N/A	Unused	
16	Output	Ignition	See Load Ratings
17	Output	Pilot	See Load Ratings
18	Output	Main Fuel Valve (Direct)	See Load Ratings
19	Output	Main Fuel Valve (Piloted)	See Load Ratings
20	Output	Release to Modulate (AUTO)	See Load Ratings
21	Input	Remote Reset	110/230 VAC, 3mA
22	Output	Flame Sensor (UVS1)	300 VDC, 3mA
23	Input	Flame Sensor Return(S2)	Sensor Common/return
24	N/A	Unused	
N	Power	Line Voltage Common	
		Protective Earth	



CAUTION: Published load ratings assume that no contact be required to handle inrush current more often than once in 15 seconds. The use of control switches, solenoid, relays, etc. which chatter can lead to premature failure. It is important to run through a test operation (with fuel shut off) following the tripping of a circuit breaker, a blown fuse, or any known instance of chattering of any external current consuming devices.



Install the wiring base where the relative humidity never reaches the saturation point. The BurnerPRO is designed to operate in a maximum 90% relative humidity environment. Do not install the BurnerPRO where it can be subjected to vibration in excess of 0.5G continuous maximum vibration. Allow at least one inch clearance (2.5 cm) around control for service and installation.

1. Wiring must comply with all applicable codes, ordinances and regulations.
2. Wiring must comply with NEC Class 1 (Line Voltage) wiring or equivalent regional code.
3. Torque rating on terminal block screws is 4.4 in/lbs to 5.3 in/lbs.
4. Limits and interlocks must be rated to simultaneously carry and break current to the ignition transformer, pilot valve and main fuel valve(s).
5. Recommended wire routing of lead wires:
 - a. Do not run high voltage ignition transformer wires in the same conduit with any other wires.
 - b. Do not route flame detector lead wires in conduit with line voltage circuits. Use separate conduit where necessary.
6. Maximum wire lengths:
 - a. The maximum lead wire length is 200ft. (61 meters) to terminal inputs (Operating limits, interlocks, valves, etc.).
 - b. Flame Detector lead wires: see section on flame scanners
 - c. Remote reset: The maximum length of wire is 500 feet (152 meters) to a normally open remote reset push-button, but should remain within sight and sound of the burner.

A good grounding system should be provided to minimize the effects of AC quality problems. A properly designed ground system meeting all the safety requirements will ensure that any AC voltage quality problems, such as spikes, surges and impulses have a low impedance path to ground. A low impedance path to ground is required to ensure that large currents involved with any surge voltages will follow the desired path in preference to alternative paths, where extensive damage may occur to equipment.



WARNING: Controls require safety limits utilizing isolated mechanical contacts. Electronic limit switches may cause erratic operation and should be avoided.

BEFORE INSTALLING THE BURNERPRO CONTROL









CAUTION: Ensure that electric power is turned off. Refer to SN-100 for recommended grounding techniques. Ensure that wiring base terminal is connected to protective earth. Be aware that power to some interlocks (operating controls, air flow switches, modulating circuits, etc.) may be derived from sources other than what is controlling the BurnerPRO.

LED INDICATOR LIGHTS







The BurnerPRO control module has seven (7) LED indicator lights to annunciate the operating status of the control, as well as provide the reason for the last lockout condition. The "Open Damper" and "Close Damper" LEDs provide easy set-up of the modulating motor end switches. Each LED has a graphic symbol to describe its function (see Table below).

Table 5:

	FAN	Lights when the blower motor is energized (terminal 6) and flashes when the RUN/CHECK switch is in the "CHECK" position during Minimum, Open, PTFI, and MTFI.
	OPEN DAMPER	Will blink when the modulator motor is being driven to the high fire position. Once the high purge switch closes, this LED will light constant. The LED provides the status of the purge sequence.
	CLOSE DAMPER	Will blink when the modulator motor is being driven to the low fire position. Once the low fire switch closes, this LED will light constant. This LED provides the status of the low fire start interlock circuit.
	AUTO	Will light when the control releases to automatic modulating control.
	IGNITION	Will blink during Pilot Trial For Ignition (PTFI). Will light constant during Main Trial For Ignition (MTFI).
	FLAME	Will light whenever flame is detected by the flame scanner.
	ALARM	In the event of a lockout condition, the Alarm LED is illuminated and the remaining LEDs will light up to indicate the lockout condition. See "Safety Lockout Codes."

The "SMART" LEDs provide a flame strength display during check mode. In check mode, the status LED is yellow, the fan LED is blinking and LEDs 2-6 grow up from status forming a bar graph. Each LED lit represents 20% of the total flame signal. See Table 6, Note 1. (5 LEDs lit is 100%, 2 LEDs is 40%)

Table 6: LED Run-time Status Indicator

OPERATION LED • = ON	FAN	OPEN DAMPER	CLOSED DAMPER	AUTO	IGNITION	FLAME	STATUS
ICON							
OFF / NO POWER							OFF
NOT READY / DIAGNOSTICS							Green
READY / STANDBY			•				Green
CHANGING (note 3)	•	OFF Blinking •	• Blinking OFF				Green
WAITING FOR AFS TO CLOSE	Blinking Green						Green
OPEN (before ignition)	•	•					Green
MINIMUM (before ignition)	•		•				Green
IGNITION	•		•		•		Green
PTFI	•		•		•	Blinking Green	Green
MTFI	•		•			•	Green
AUTO	•			•		•	Green
MINIMUM (During Flame)	•		•			•	Green
OPEN (During Flame)	•	•				•	Green
ECONOMY	•		•				Green
CHECK OPEN	Blinking	•					Yellow
CHECK MINIMUM	Blinking		•				Yellow
CHECK PTFI	Blinking	• Note 1	• Note 1	• Note 1	• Note 1	• Note 1	Yellow
CHECK MTFI	Blinking	• Note 1	• Note 1	• Note 1	• Note 1	• Note 1	Yellow
FAULT / LOCKOUT	• Note 2	• Note 2	• Note 2	• Note 2	• Note 2	• Note 2	Red
END OF CYCLE	•		•	•	•		Green

NOTES:

1. The LEDs form a progress bar indicating Flame Signal Strength for aiming sensors during commissioning (The LEDs “Grow” upwards away from Status at 20% intervals of flame strength.)
2. The LEDs indicate the error or lockout code for troubleshooting
3. The LEDs change from ON to BLINKING to OFF showing the modulator operation

FLAME SCANNERS

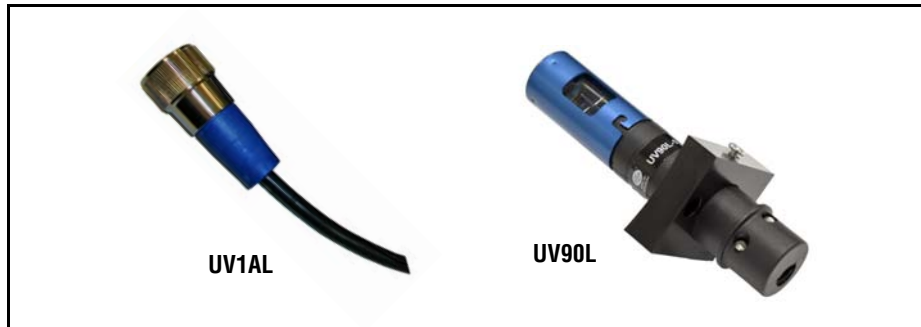

INSTALLATION - UV SCANNERS

Where possible, obtain the burner manufacturer's instructions for mounting the scanner. This information is available for most standard burners. The scanner mounting should comply with the following general instructions:

1. Position the UV1AL, UV90L or UV5 scanner within 39 inches (1 meter) of the flame to be monitored. Consult SC-108 bulletin for more information.
2. Select a scanner location that remains within the ambient temperature limits of the UV Scanner.
3. The UV1AL scanner is designed to seal off the sight pipe up to 1 PSI pressure. Higher furnace pressures must be sealed off. To seal off positive furnace pressure up to 50 PSI for the UV1AL scanner, install a quartz window coupling (#60-1257). Add cooling air to reduce the scanner sight pipe temperature.
4. Install the scanner on a standard NPT pipe (UV1AL: 1/2") whose position is rigidly fixed. If the scanner mounting pipe sights through the refractory, do not extend it more than halfway through. Swivel flanges are available if desired (P/N: 60-302). The sight pipe must permit an unobstructed view of the pilot and/or main flame, and both pilot and main flames must completely cover the scanner field of view.

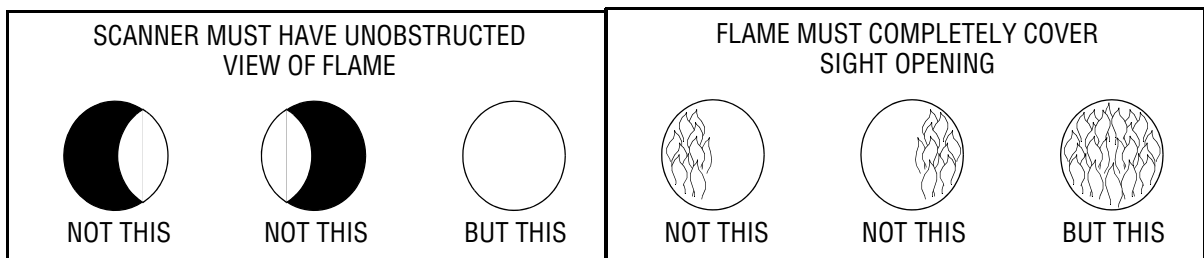

5. Smoke or unburned combustion gases absorb ultra-violet energy. On installations with negative pressure combustion chambers, a small hole drilled in the UV1AL sight pipe assists in keeping the pipe clean and free from smoke. For positive pressure furnaces, provide clean air to pressurize the sight pipe, if necessary.
6. Two UV Scanners may be installed on the burner if it is necessary to view two areas to obtain reliable detection of the flame. They must be wired in parallel.
7. To increase scanner sensitivity with UV1AL scanner, a quartz lens permits location of the scanner at twice the normal distance. Use 1/2" x 1 1/2" pipe nipple between UV1AL scanner and the coupling.
8. Request the assistance of any Fireye field office for recommendations of a proper scanner installation on a non-standard application.

TYPICAL SCANNER INSTALLATIONS

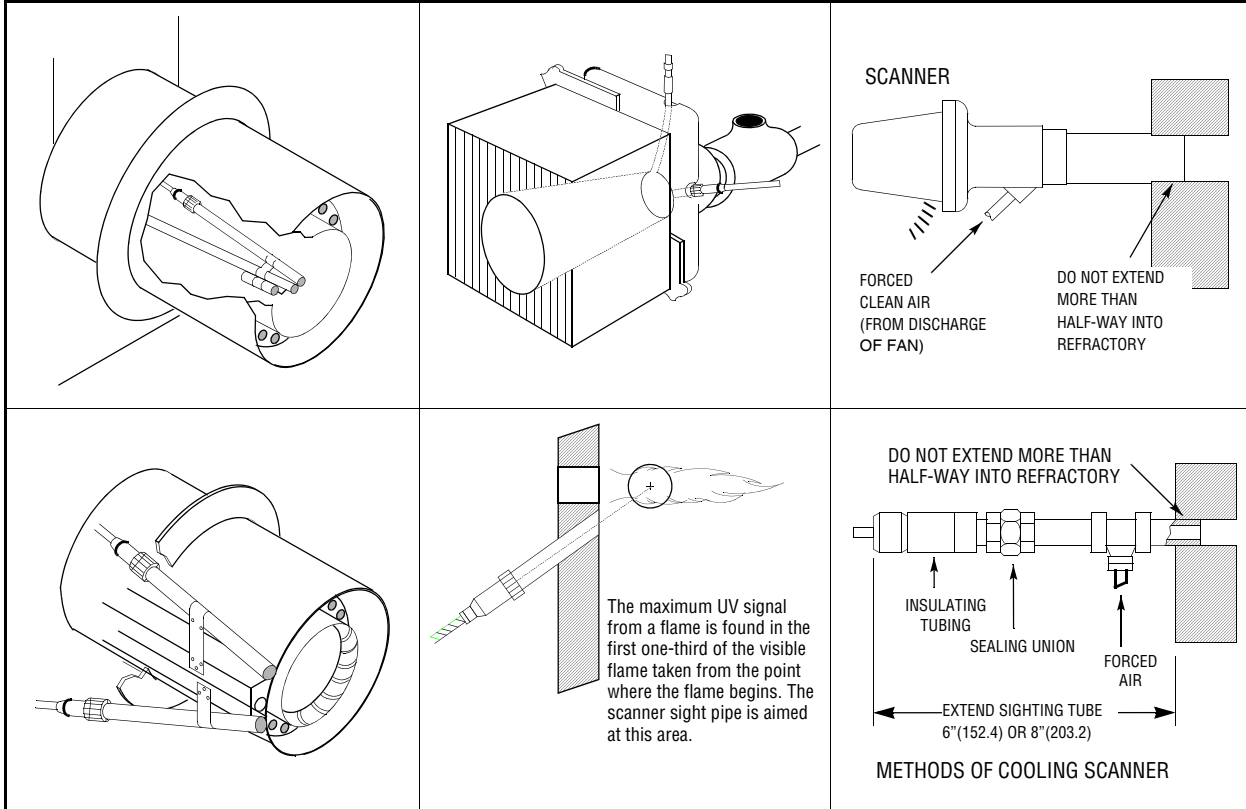



WIRING - UV SCANNERS

To connect the scanner to the control, the UV1AL scanner is supplied with 36" or 72" (0.9 m or 1.8 m) of flexible cable. The UV90L is supplied with a terminal block. Use two #18 AWG conductors to connect the UV90L to the control. The UV5 is supplied with 80" (2m) of flexible cable (detachable).

If it is necessary to extend the scanner wiring, the following instructions apply:

There is no polarity associated with the scanner wiring, except for the UV5. Scanner wires must be installed in a separate conduit. The wires from several scanners may be installed in a common conduit.

1. Selection of Wire
 - a. Wiring: For extended scanner wiring up to 500 feet (152 M), and for shorter lengths to reduce signal loss, use a shielded wire (Belden 8254-RG62 coaxial cable, or equal) for each scanner wire. The ends of the shielding must be taped and not grounded.
 - b. Avoid asbestos insulated wire.
 - c. Multi-conductor cable is not recommended without prior factory approval.
2. High voltage ignition wiring must not be installed in the same conduit with flame detector wires.

SYSTEM OPERATION

The fixed series timings determine the functional operation of the BurnerPRO control (e.g. purge timing, trial for ignition timings, etc.) The BurnerPRO offers a single multi-functional button and its functions are as follows:

RESET

The BurnerPRO control provides two methods of resetting the control in the event of a safety lock-out: The push button reset and terminal 21 remote reset. Both reset methods can be used to stop the control in its firing sequence at anytime to force a user/emergency lockout. A reset of the control can be accomplished by momentarily pressing the reset button or engaging the remote reset terminal.

CHECK MODE

The push button reset switch has an added feature that allows the user to freeze the operational sequence at certain times (Purge, Ignition, PTFI, and MTFI). This is known as CHECK MODE and it is designed to aid in set-up, start-up and check-out of the burner and its associated interlocks. This feature is very useful in pilot aiming and adjustment during commissioning or maintenance.

The check mode rules are:

- If the push button reset is held for at least 3 seconds, the status LED changes from green to yellow to signal that the control is in check mode.
- Momentarily pressing the push button reset while in check mode transitions the control into normal operating sequence, thus disabling check mode.
- The control locks out during Purge, Ignition, or PTFI states if check mode is active longer than 30 minutes
- The control allows check mode in MTFI for 2 minutes. The control automatically cancels check mode after 2 minutes in MTFI state and resumes normal operation.
- When in check mode during PTFI or MTFI states, the control uses the *open*, *close*, *auto*, *ignition*, and *flame* LEDs to annunciate the flame signal strength. Every illuminated LED (starting with the flame LED) represents a 20% signal strength.

FIGURE 3. OPERATIONAL SEQUENCE

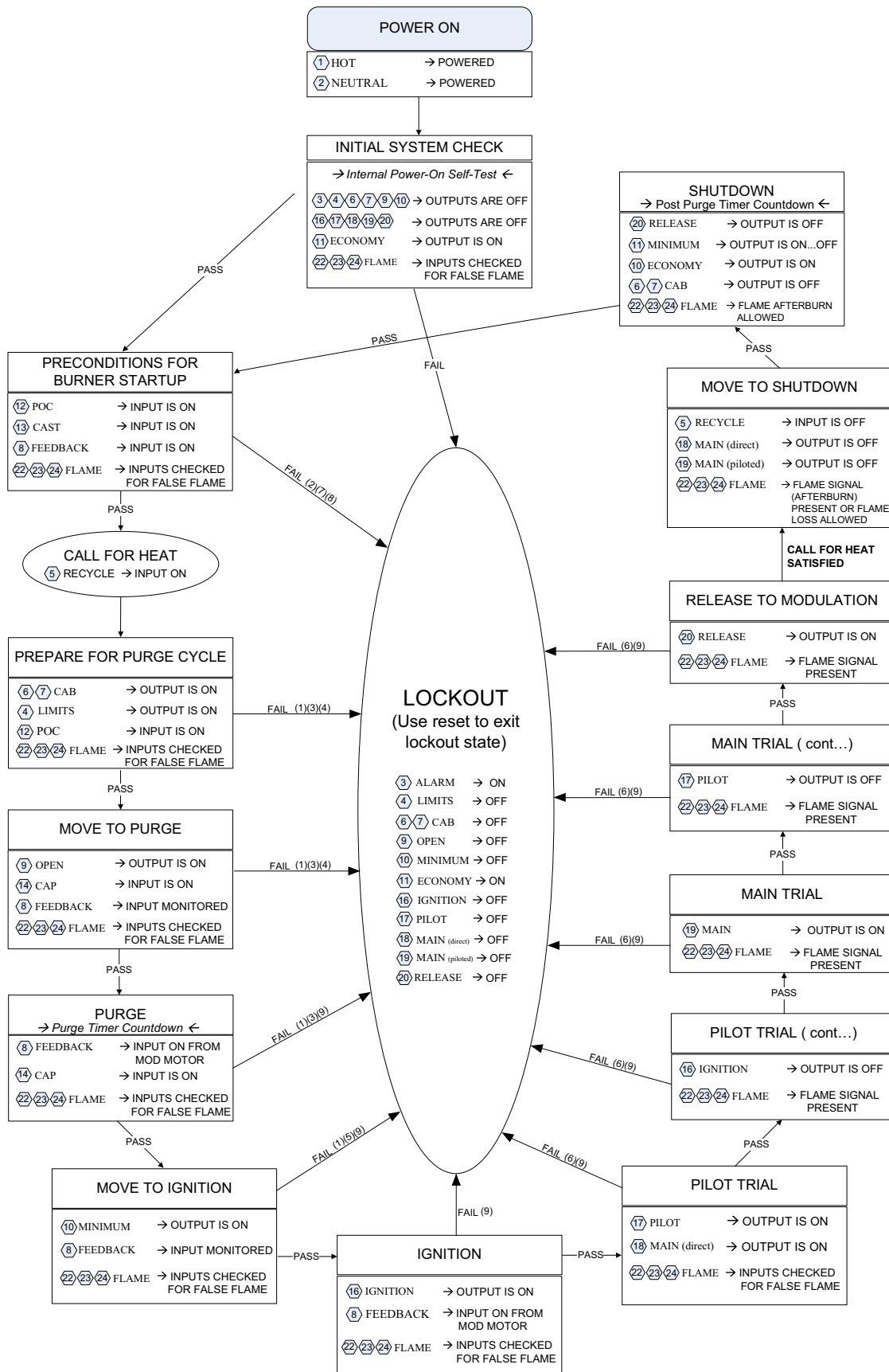



NOTES:

- 1) *Presence of flame at this point results in a lockout.*
- 2) *When CAST (terminal 13) is open and POC (terminal 12) is open at this point, control locks out after 10 minutes. When CAST is open and POC is closed, control remains in same state indefinitely.*
- 3) *Control locks out if FEEDBACK (terminal 8) is not present after 10 minutes.*
- 4) *CAP (terminal 14) input is required to proceed. Otherwise, control locks out, after 10 minutes.*
- 5) *FEEDBACK (terminal 8) must remain present. Otherwise, control locks out, after 10 minutes.*
- 6) *Presence of real flame is mandatory. Otherwise, control locks out. Flame failure results in Post-Purge at lockout.*
- 7) *The control locks out if POC (FVES) cannot be proven closed upon call for heat.*

EXPLANATION OF SEQUENCE STATES

1) POWER ON

This is the application of power to the control. It's important that a single phase (110/230 VAC 50/60 Hz) is applied to the control and the inputs to the control are sourced from the same phase.

2) INITIAL SYSTEM CHECK

During this state, the control undergoes an internal Power-On Self-Test (POST) to verify that the hardware and software are operating properly. The non-volatile lockout feature forces the control to move to lockout if the last lockout condition was not cleared prior to power off. The control further checks the critical input and output terminals to make sure they are in the proper state. The control expects the flame to be completely extinguished at this point.

3) PRECONDITIONS FOR BURNER STARTUP

The control verifies that the air-flow switch is in the Normally Closed position via the Combustion Air Switch Test (CAST) input and a verification of the main fuel shutoff valve (POC/FVES) is performed as well. Flame must not be present at this point. Failure to prove POC or CAST input will lead to a halt in the state sequence or the control will proceed to lockout.

4) CALL FOR HEAT

The recycle limit (terminal 5) is energized to alert the control to start a burner cycle.

5) PREPARE FOR PURGE CYCLE

The control turns on the combustion blower (terminals 6 & 7).

6) MOVE TO PURGE

The control commands the damper actuator to move to the OPEN (high fire) position. It expects the actuator to report a successful transition to the OPEN position by energizing the FEEDBACK input (terminal 8). The control also checks to make sure that the airflow switch is operating by monitoring the CAP input.

7) PURGE

The control purges the combustion vessel for a period of time (length of purge is based on the control series installed).

8) MOVE TO IGNITION

Upon successful purging, the control moves to ignition by energizing the MINIMUM output (terminal 10). It expects the actuator to report a successful transition to the MINIMUM (LOW FIRE) position by energizing the FEEDBACK input (terminal 8). Flame must not be present at this point.

9) IGNITION

The control energizes the ignition transformer by activating terminal 16. It's critical that the damper actuator remain at the MINIMUM (LOW FIRE) position during this state. Flame must not be present at this point.



10) PILOT TRIAL (1st safety time)

The control turns on the pilot flame by energizing terminal 17. The MAIN direct output (terminal 18) is also energized for systems that implement direct light-off of the main flame during pilot. The control doesn't check for flame during this phase as the flame may not be fully established.

11) PILOT TRIAL (1st safety time)

The ignition transformer is turned off. The pilot flame signal is proven during this phase. Failure to "see" a flame results in a lockout.

12) MAIN TRIAL (2nd safety time)

The main fuel valve (piloted) output (terminal 19) is energized to light-off the main flame. Flame signal must be present during this phase.

13) MAIN TRIAL (2nd safety time)

The pilot output (terminal 17) is turned off during this phase. Flame signal must remain present.

14) RELEASE TO MODULATION

After successfully establishing flame, the control proceeds to relinquish modulation control to the boiler management system. Flame signal must remain present. Terminal 20 is energized.

15) MOVE TO SHUTDOWN

Move to shutdown occurs when the load demand has been satisfied and the RECYCLE LIMIT (terminal 5) is open. This forces the control to close the main fuel valves by de-energizing MAIN_direct (terminal 18) and MAIN_piloted (terminal 19) outputs. The combustion air blower remains on for post-purge. Flame afterburn is allowed during this phase

16) SHUTDOWN

The control proceeds to purge the combustion chamber for a period of time (length of post-purge is based on the control series installed). Then it proceeds to the MINIMUM (low-fire) position and later to the ECONOMY (closed) position. After successfully completing a post-purge cycle, the control turns off the combustion air blower. Any flame afterburn is expected to be completed at the completion of post-purge.

17) LOCKOUT

The control proceeds to a lockout state when it detects an internal or external fault condition. The reset button and remote reset terminal can be used to exit the lockout state. However, the control will revert to lockout if the fault condition is not rectified.

FIGURE 4.

SEQUENCE TIMING:

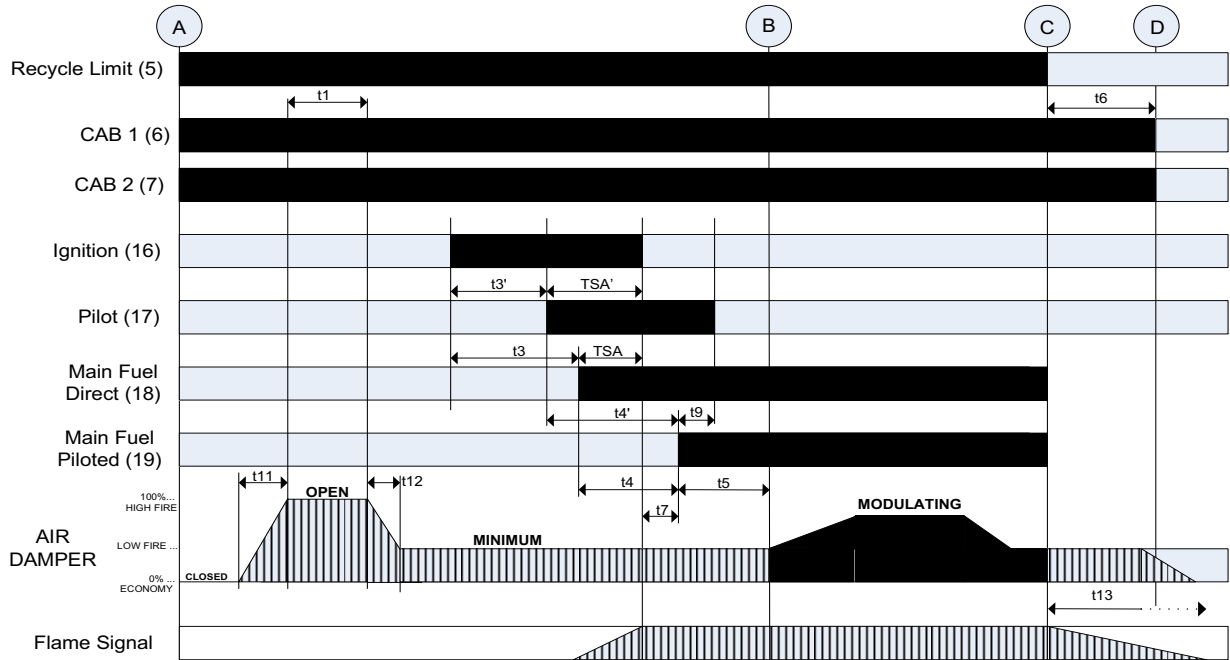

LEGEND

- A – Start command (Call for Heat)
- B – Release to modulation
- C – End of burner fuel cycle
- D – End of operating sequence

- t1– Purge time
- t3 – Pre-ignition time (direct fired)
- t3' – Interval between Ignition and Pilot valve (piloted)
- TSA' – Ignition safety time -- Interval between Pilot and Ignition (PTFI)
- TSA – Ignition safety time -- Interval between Main Fuel Direct and Ignition
- t4 – Interval between voltage on Pilot/Main Fuel Direct and Main Fuel Piloted
- t4' – Interval between Pilot and the Main Fuel Piloted
- t5 – Interval between Main Fuel Piloted and release to Modulation
- t6 – Post-purge time
- t7 – Pilot stabilization period
- t9 – Interval between Main Fuel Piloted and removal of Pilot (MTFI)
- t11 – Air damper running time to the HIGH FIRE position
- t12 – Air damper running time to the LOW FIRE position
- t13 – Permissible afterburn time

SEQUENCE TIMING S6:

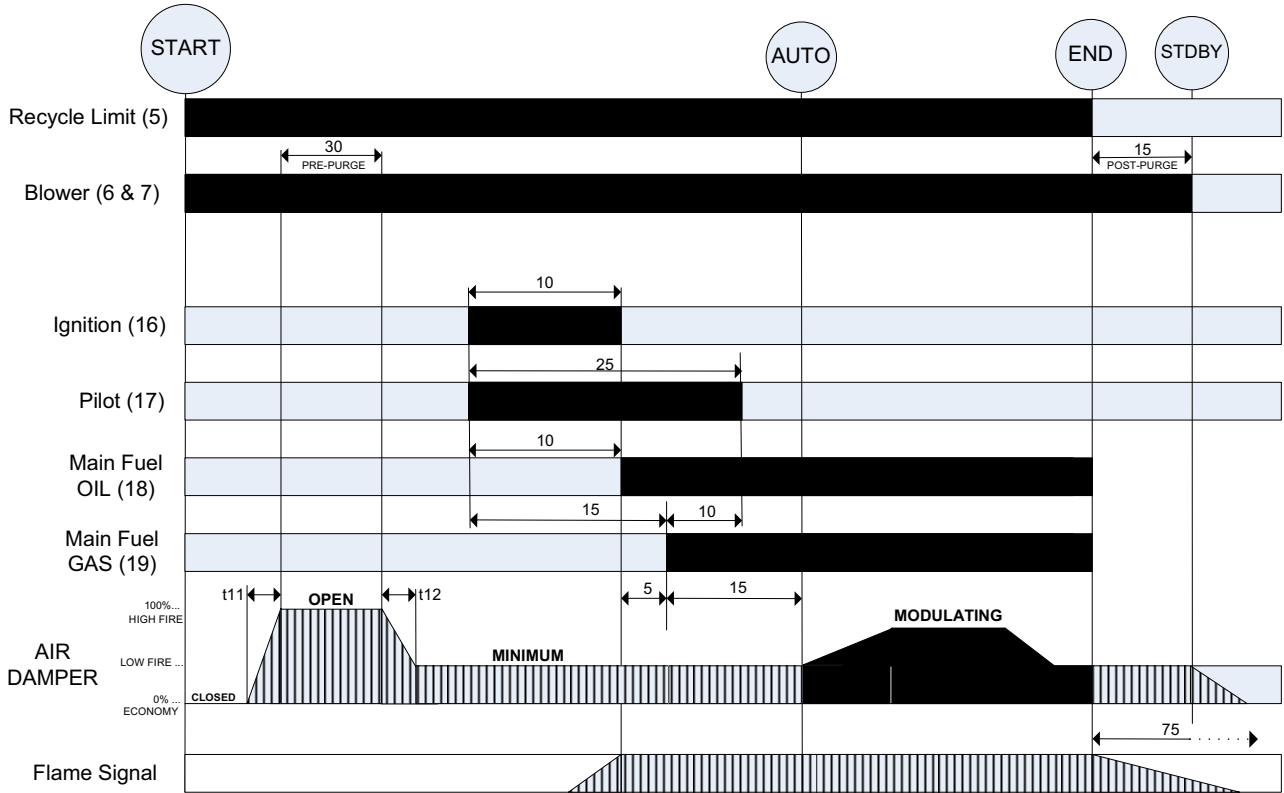

LEGEND

- A – Start command (Call for Heat)
- B – Release to modulation
- C – End of burner fuel cycle
- D – End of operating sequence

- t1– Purge time
- t3 – Pre-ignition time (direct fired)
- TSA' – PTFI
- t4 – Interval between voltage Main Fuel Oil and Main Fuel Gas
- t4' – Internal between Pilot and the Main Fuel Gas
- t5 – Interval between Main Fuel Gas and release to Modulation
- t6 – Post-purge time
- t7 – Pilot stabilization period
- t9 – MTFI
- t11 – Air damper running time to the HIGH FIRE position
- t12 – Air damper running time to the LOW FIRE position
- t13 – Permissible afterburn time

TIMING	S6
t1	30
t3	10
TSA'	10
t4	5
t4'	15
t5	15
t6	15
t7	5
t9	10
t11	5 ^a
t12	5 ^a
t13	75
FFRT	4.0

NOTE:
a. Minimum time 5 seconds
Maximum time 10 minutes

Table 7:

Times are in seconds		BURNERPRO SERIES (50Hz)			
TIMING	DESCRIPTION	S1	S2	S3	S6
t1	Purge time	36 ^a	31 ^a	37 ^a	30 ^a
t3	Pre-ignition time (direct fired)	4	6	5	10
t3'	Pre-ignition time (piloted)	4	6	2.5	0
TSA	Ignition safety time (direct ignition)	2 ^b	3 ^b	2.5 ^b	0 ^b
TSA'	Ignition safety time (PTFI)	2 ^b	3 ^b	5 ^b	10 ^b
t4	Interval between voltage on Pilot/Main Fuel Direct and Main Fuel Piloted	10	11.5	12.5	5
t4'	Interval between start of TSA and the main fuel piloted	10	11.5	15	15
t5	Interval between Main Fuel Piloted and release to Modulation	10	11.5	12.5	15
t6	Postpurge time	12 ^a	17 ^a	15 ^a	15 ^a
t7	Pilot stabilization period	8	8.5	10	5
t9	Interval between Main Fuel Piloted and removal of Pilot (MTFI)	2	3	5	10
t11	Air damper running time to the HIGH FIRE position	OPTIONAL			
t12	Air damper running time to the LOW FIRE position	OPTIONAL			
t13	Permissible afterburn time (Post-purge + 30s)	42	47	45	75
FFRT	Flame Failure Response Time (FFRT)	1.0 ^b			4.0 ^b

Times are in seconds		BURNERPRO SERIES (60Hz)			
TIMING	DESCRIPTION	S1	S2	S3	S6
t1	Purge time	30 ^a	25.8 ^a	30.8 ^a	30 ^a
t3	Pre-ignition time (direct fired)	3.3	5	4.2	10
t3'	Pre-ignition time (piloted)	3.3	5	2.1	0
TSA	Ignition safety time (direct ignition)	2.0 ^b	2.5 ^b	2.1 ^b	0 ^b
TSA'	Ignition safety time (PTFI)	2.0 ^b	2.5 ^b	4.2 ^b	10 ^b
t4	Interval between voltage on Pilot/Main fuel direct and Main fuel piloted	8.3	9.6	10.4	5
t4'	Interval between start of TSA and the main fuel piloted	8.3	9.6	12.5	15
t5	Interval between Main fuel piloted and release to Modulation	8.3	9.6	10.4	15
t6	Postpurge time	10 ^a	14.2 ^a	12.5 ^a	15 ^a
t7	Pilot stabilization period	6.7	7.1	8.3	5
t9	Interval between Main fuel piloted and removal of pilot (MTFI)	1.7	2.5	4.2	10
t11	Air damper running time to the OPEN (HIGH FIRE) position	OPTIONAL			
t12	Air damper running time to the MINIMUM (LOW FIRE) position	OPTIONAL			
t13	Permissible afterburn time (Post-purge + 30s)	40	44.2	42.5	75
FFRT	Flame Failure Response Time (FFRT)	1.0 ^b			4.0 ^b

NOTE: unless stated as minimum or maximum, timings are nominal values.

a: Minimum time

b: Maximum time

FIGURE 5.

EXAMPLE WIRING DIAGRAM FOR SINGLE STAGE BURNER w/ DIRECT IGNITION

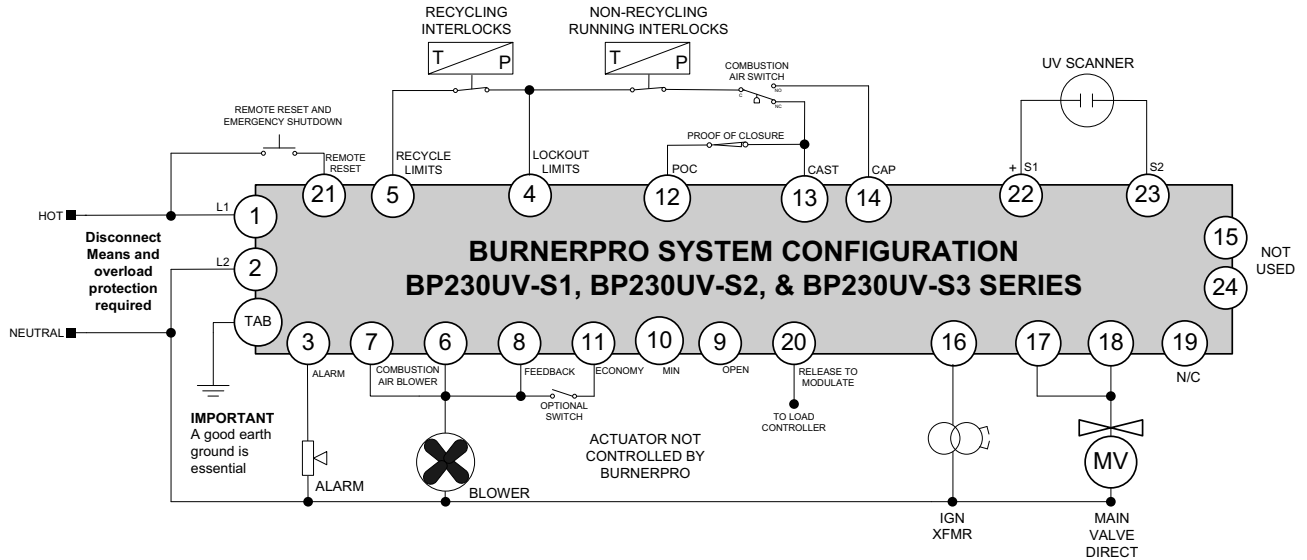

1. No Pilot -- Main flame is established shortly after Ignition transformer is energized (see timing table).
2. MIN represents the LOW FIRE position.
3. OPEN represents the HIGH FIRE position.
4. POC represents Proof of Closure – otherwise known as Fuel Valve End Switch.
5. Recycling Interlocks are general one or more limits switches in series (High/Low gas pressure, Oil temperature, etc) that are used to stop the burner when the limit switch opens and restart when the limit switch recloses.
6. Non-Recycling Interlocks are general one or more limits switches in series (High steam pressure, Low water, etc) that are used to stop the burner when the limit switch opens and prevent it from restarting until both the limit switch recloses and the manual/remote reset is activated.
7. CAST is defined as the Combustion Air Switch Test.
8. CAP is defined as the Combustion Air Prove.
9. Combustion Air Blower Terminals 6 & 7 are tied internally.

All wiring must comply with regional and local codes.

Caution: All safety limit switches should be approved as limit controls and should be wired directly in the circuit of the Flame Safeguard control. The use of electronic switches to close interlock circuits may cause erratic operation.

Typical Mains connection

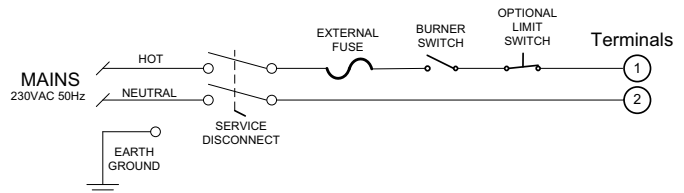

Proper grounding is necessary. Wiring base ground terminal should be attached to grounded bonding screw in cabinet

FIGURE 6.

EXAMPLE WIRING DIAGRAM FOR MODULATING BURNER w/ INTERMITTENT PILOT

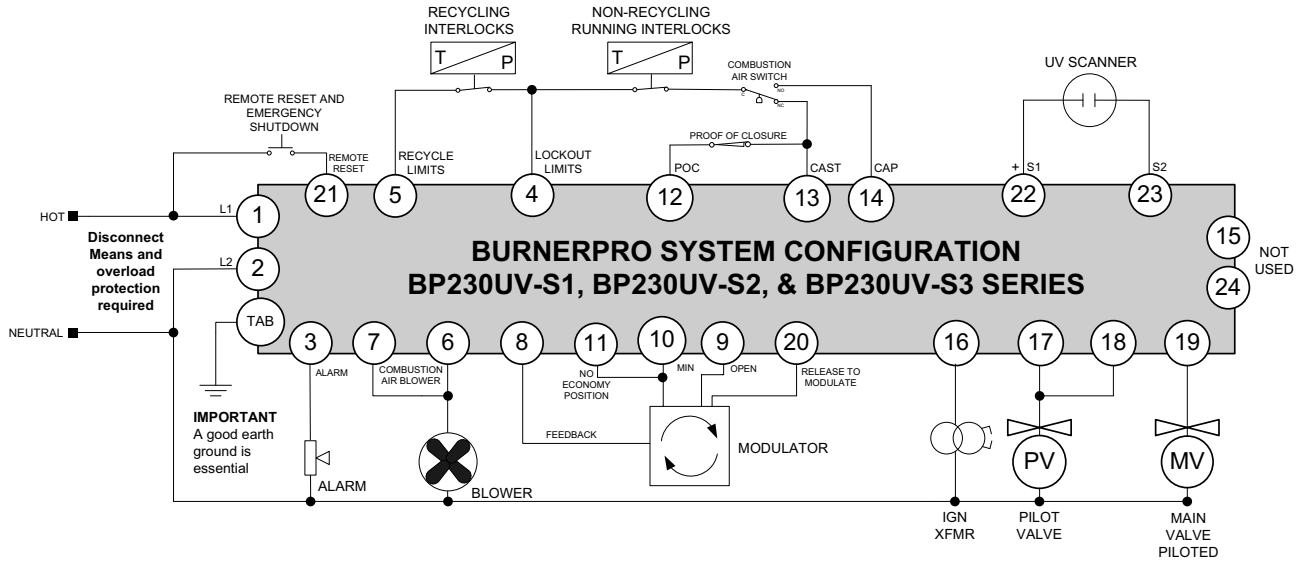

1. Pilot is on when burner is on.
2. MIN represents the LOW FIRE position.
3. OPEN represents the HIGH FIRE position.
4. POC represents Proof of Closure – otherwise known as Fuel Valve End Switch.
5. Recycling Interlocks are general one or more limits switches in series (High/Low gas pressure, Oil temperature, etc) that are used to stop the burner when the limit switch opens and restart when the limit switch recloses.
6. Non-Recycling Interlocks are general one or more limits switches in series (High steam pressure, Low water, etc) that are used to stop the burner when the limit switch opens and prevent it from restarting until both the limit switch recloses and the manual/remote reset is activated.
7. CAST is defined as the Combustion Air Switch Test.
8. CAP is defined as the Combustion Air Prove.
9. Combustion Air Blower Terminals 6 & 7 are tied internally.

All wiring must comply with regional and local codes.

Caution: All safety limit switches should be approved as limit controls and should be wired directly in the circuit of the Flame Safeguard control. The use of electronic switches to close interlock circuits may cause erratic operation.

Typical Mains connection

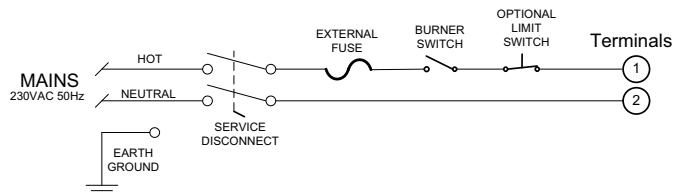

Proper grounding is necessary. Wiring base ground terminal should be attached to grounded bonding screw in cabinet

FIGURE 7.

EXAMPLE WIRING DIAGRAM FOR MODULATING BURNER w/ INTERRUPTED PILOT

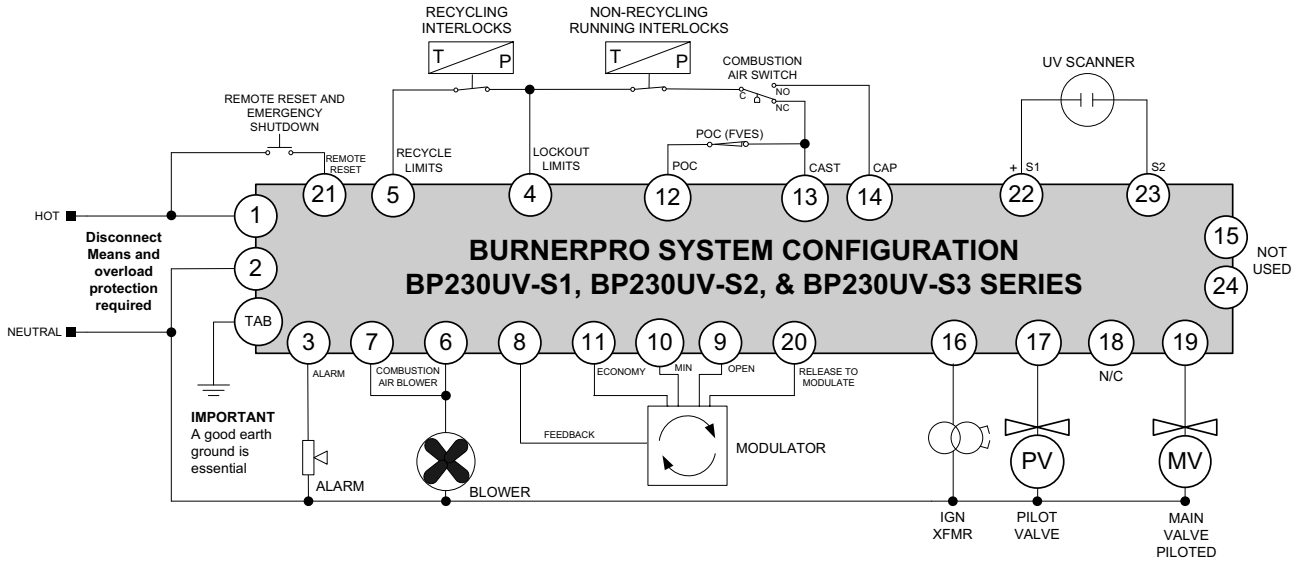

1. Pilot is only on during Ignition.
2. MIN represents the LOW FIRE position.
3. OPEN represents the HIGH FIRE position.
4. POC represents Proof of Closure – otherwise known as Fuel Valve End Switch.
5. Recycling Interlocks are general one or more limits switches in series (High/Low gas pressure, Oil temperature, etc) that are used to stop the burner when the limit switch opens and restart when the limit switch recloses.
6. Non-Recycling Interlocks are general one or more limits switches in series (High steam pressure, Low water, etc) that are used to stop the burner when the limit switch opens and prevent it from restarting until both the limit switch recloses and the manual/remote reset is activated.
7. CAST is defined as the Combustion Air Switch Test.
8. CAP is defined as the Combustion Air Prove.
9. Combustion Air Blower Terminals 6 & 7 are tied internally.
10. If equipped, the ECONOMY position may be used to fully close the air damper. Thus, reducing heat losses.

All wiring must comply with regional and local codes.

Caution: All safety limit switches should be approved as limit controls and should be wired directly in the circuit of the Flame Safeguard control. The use of electronic switches to close interlock circuits may cause erratic operation.

Typical Mains connection

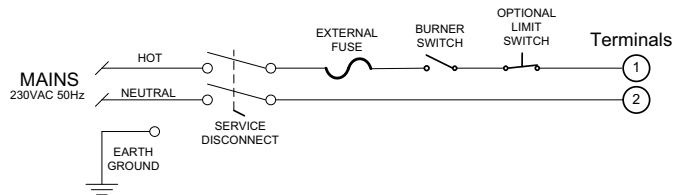

Proper grounding is necessary. Wiring base ground terminal should be attached to grounded bonding screw in cabinet



DESCRIPTION OF FUNCTIONS OF OPERATING CONTROLS

1. **Limit Switches:** These are generally pressure, water level or temperature activated. There are two types which are:
 - a. Recycle - when it is desired to start the burner or a call for heat is present, the limit switch closes causing the burner start-up sequence to begin. When it is desired to stop the burner or the setpoint has been satisfied, the limit switch opens causing the burner to stop. The recycle limit is connected between terminal 4 and 5.
 - b. Non-Recycle/Lockout -when it is necessary to stop the burner when the limit switch opens and prevent it from starting until both the limit switch recloses and the manual reset is activated. The non-recycle limit is connected between terminals 4 and 14.
2. **Proof of Closure Interlock:** This is generally an integral switch mounted on the main fuel valve and activated by the valve stem. It is connected between Terminal 4 & 12 when burner is idle. The POC switch interlock prevents a burner start-up if the valve stem is not in the "valve closed" position. This interlock must remain closed while in STANDBY and until the start of PTFI.
3. **Purge Interlock:** Generally a firing rate motor linkage position switch or a differential air-pressure switch, that proves a maximum purge air flow rate. It is connected between Terminals 8 and 9. The purge interlock proves that the air damper is fully open and purge air flow rate is at maximum during the purge.
3. **Running Interlocks:** These generally are high and low fuel pressure switches, oil temperature switches, atomizing media pressure switches, and excess smoke density controls. These interlocks prove proper conditions for normal operation of the burner.

LOCKOUTS

When a safety shutdown occurs, the control LEDs indicate the reason for the lockout. The alarm circuit (Terminal “3”) is energized. The non-volatile memory remembers the status of the control even if a power failure occurs. By momentarily depressing and releasing the manual reset button on the control or Terminal 21 remote reset, the control can be reset. The button must be held down for one second and then released. Very little force is required to do this. Do not press hard.

RESETTING THE CONTROL

The BurnerPRO system contains 2 methods of reset: Push button reset and remote terminal reset. The remote reset should be a normally open switch connected from line voltage to terminal 21 (see example wiring diagrams).

- Reset is required following a non-volatile lockout.
- Depressing the push button reset momentarily causes the system to recover from a lockout.
- Depressing and releasing the reset button during run mode causes the control to go into lockout.
- The BurnerPRO limits the amount of remote reset attempts to 5 tries in a 15 minutes window.

BURNERPRO LED ERROR / LOCKOUT CODES

During an alarm condition, the status LED turns solid red. The remaining LEDs are illuminated as a coded sequence identifying the reason for the lockout. The following table shows the various LED Lockout codes:



WARNING: The equipment described in this manual is capable of causing property damage, severe injury, or death. It is the responsibility of the owner or user to ensure that the equipment described is installed, operated and commissioned in compliance with the requirements of all national and local codes.









WARNING!!!



Boiler operation, maintenance, and troubleshooting shall only be conducted by trained personnel. Persons troubleshooting lockouts or resetting the control must respond properly to troubleshooting error codes as described in this product bulletin.

Jumpers being used to perform static test on the system must only be used in a controlled manner and must be removed prior to the operation of the control. Such tests may verify the external controllers, limits, interlocks, actuators, valves, transformers, motors and other devices are operating properly. Such tests must be conducted with manual fuel valves in the closed position only. Replace all limits and interlocks not operating properly, and do not bypass limits in interlocks. Failure to follow these guidelines may result in an unsafe condition hazardous to life and property.

Table 8: BurnerPRO LED ERROR / LOCKOUT CODES

NO	FAULT	LED 1	LED 2	LED 3	LED 4	LED 5	LED 6	LED 7
	OPERATION LED • = ON	FAN	OPEN DAMPER	CLOSED DAMPER	AUTO	IGNITION	FLAME	STATUS
	ICON							
1	MAIN MCU INPUT DIAG FAULT	•						RED
2	LOCAL RESET		•					RED
3	CAB_FAULT	•	•					RED
4	SUPERVISORY MCU INPUT DIAG FAULT			•				RED
5	RESET LIMIT CROSSED	•		•				RED
6	NOT USED							
7	SPI COMMUNICATION FAULT	•	•	•				RED
8	REMOTE RESET				•			RED
9	NOT USED							
10	MAIN PROGRAM SEQ FAULT		•		•			RED
11	RAM TEST	•	•		•			RED
12	SUPV PROGRAM SEQ FAULT			•	•			RED
13	INPUT READING FAULT	•		•	•			RED
14	TIMER2 FAULT		•	•	•			RED
15	CPU TEST FAIL	•	•	•	•			RED
16	FLAME LOSS PTFI	•				•		RED
17	CHECK WIRING FAULT		•			•		RED
18	SAFETY RELAY FAULT	•	•			•		RED
19	FUEL VALVE OPEN FAULT			•		•		RED
20	FLAME LOSS MTFI	•		•		•		RED
21	SAFETY RELAY WELDING FAULT		•	•		•		RED
22	SUPV SELF-TEST	•	•	•		•		RED
23	SUPV CS ROM FAIL				•	•		RED
24	FLAME LOSS AUTO	•			•	•		RED
25	SUPV RAM CHECK FAIL		•		•	•		RED
26	SUPV INTERNAL ERROR	•	•		•	•		RED
27	FLAME DETECTED SHUTDOWN MODE			•	•	•		RED
28	NOT USED							RED
29	SUPV TEMP RANGE FAULT		•	•	•	•		RED



NO	FAULT	LED 1	LED 2	LED 3	LED 4	LED 5	LED 6	LED 7
30	ROM FAILURE	•	•	•	•	•		RED
31	NOT USED							
32	CHECK MODE TIMEOUT	•					•	RED
33	STANDBY FALSE FLAME		•				•	RED
34	NOT USED							
35	SW WDT RESET			•			•	RED
36	SW RESET	•		•			•	RED
37	INPUTS WAITING TIME FAULT		•	•			•	RED
38	SUPV SW WDT RESET	•	•	•			•	RED
39	SUPV SW RESET				•		•	RED
40	HARDWARE RESET	•			•		•	RED
41	SUPV HARDWARE RESET		•		•		•	RED
42	MAIN LOOP STUCK FAULT	•	•		•		•	RED
43	SUPV LOOP STUCK FAULT			•	•		•	RED
44	SUPV TIMER2 FAULT	•		•	•		•	RED
45	MAIN AC PEAK MISSING FAULT		•	•	•		•	RED
46	SUPV AC PEAK MISSING FAULT	•	•	•	•		•	RED
47	UV PULSE INPUT MISSMATCH					•	•	RED
48	SUPERVISORY MCU ADC FAULT	•				•	•	RED
49	MAIN MCU ADC FAULT		•			•	•	RED
50	IGNITION FEEDBACK FAULT	•	•			•	•	RED
51	PILOT_FEEDBACK_FAULT			•		•	•	RED
52	MAINP_FEEDBACK_FAULT	•		•		•	•	RED
53	FEEDBACK_WAITING_TIME_EXPIRE		•	•		•	•	RED
54	MAIND_FEEDBACK_FAULT	•	•	•		•	•	RED
55	INTERRUPT DIAG FAULT				•	•	•	RED
56	FALSE_FLAME_ERROR			•	•	•	•	RED
57	POWERON_FALSE_FLAME_ERROR	•		•	•	•	•	RED
58	OPEN_FEEDBACK_READING_FAULT		•	•	•	•	•	RED
59	ADJACENT PIN SHORT FAULT	•			•	•	•	RED
60	LOCAL RESET DEBOUNCE FAULT	•	•	•	•	•	•	RED
61	POC OPEN FAULT		•		•	•	•	RED
62	STRONG UV FLAME FAULT	•	•		•	•	•	RED
63	SPI CRC FAULT					•		RED

This table shows the various required LED error/lockout codes displayed on the BurnerPRO after a fault or error has occurred.



Table 9: LOCKOUT CODE EXPLANATION:

The following list provides error code explanations to help people in the field respond more effectively to issues that arise.

NO	FAULT	POSSIBLE REMEDY
1	MAIN MCU INPUT DIAG FAULT	Initial power diagnostic failure. Make sure inputs and outputs are in the proper state at power on.
2	LOCAL RESET	User initiated manual reset or faulty reset switch.
3	CAB_FAULT	Air Prove [terminal 14] signal did not prove at the end of ignition safety time or loss of Air Prove signal during burner operation
4	SUPERVISORY MCU INPUT DIAG FAULT	"System detected voltage on terminal 16, 17, 18, or 19 at the wrong time or voltage is not present when needed. Check wiring and make sure the system is operating on a single line phase (50/60Hz)"
5	RESET LIMIT EXCEEDED	Remote reset button pressed more than 5 times in 15 minutes. User should address lockout condition. Reset functionality will be re-established in a few minutes.
6	NOT USED	
7	SPI COMMUNICATION FAULT	Reset the system to continue normal operation. Contact distributor/factory if error persists.
8	REMOTE RESET	User pressed remote reset or erratic/bouncy remote switch.
9	NOT USED	
10	MAIN PROGRAM SEQ FAULT	Replace control. Contact distributor/factory.
11	RAM TEST	Replace control. Contact distributor/factory.
12	SUPV PROGRAM SEQ FAULT	Replace control. Contact distributor/factory.
13	INPUT READING FAULT	Please check wiring and make sure the system is operating on a single line phase (50/60Hz)
14	TIMER2 FAULT	Replace control. Contact distributor/factory.
15	CPU TEST FAIL	Replace control. Contact distributor/factory.
16	FLAME LOSS PTFI	Check scanner sighting and confirm that the pilot is established during PTFI. Check fuel delivery system.
17	CHECK WIRING FAULT	"System detected voltage on terminal 16, 17, 18, or 19 at the wrong time or voltage is not present when needed. Check wiring and make sure the system is operating on a single line phase (50/60Hz)"
18	SAFETY RELAY FAULT	Replace control. Contact distributor/factory.
19	FUEL VALVE OPEN FAULT	Check wiring for POC. Fuel valves may not be fully closed.
20	FLAME LOSS MTFI	Check scanner sighting and confirm that the main flame is established during MTFI. Check fuel delivery system.
21	SAFETY RELAY WELDING FAULT	Replace control. Contact distributor/factory.
22	SUPV SELF-TEST	Replace control. Contact distributor/factory.
23	SUPV CS ROM FAIL	Replace control. Contact distributor/factory.
24	FLAME LOSS AUTO	Check wiring. Check scanner. Check fuel delivery system
25	SUPV RAM CHECK FAIL	Replace control. Contact distributor/factory.
26	SUPV INTERNAL ERROR	Replace control. Contact distributor/factory.
27	FLAME DETECTED SHUTDOWN MODE	False flame detected after the permissible afterburn period. Check boiler and fuel delivery system.
28	NOT USED	
29	SUPV TEMP RANGE FAULT	Ambient temperature below -40oC or more than 70oC
30	ROM FAILURE	Replace control. Contact distributor/factory.
31	NOT USED	
32	CHECK MODE TIMEOUT	Check mode expiration window (30 minutes) elapsed.
33	STANDBY FALSE FLAME	False flame detected during Standby state. Check wiring. Check scanner.
34	NOT USED	
35	SW WDT RESET	Internal software reset by Microcontroller. Contact distributor/factory if error persists.
36	SW RESET	Internal software reset by Microcontroller. Contact distributor/factory if error persists.



NO	FAULT	POSSIBLE REMEDY
37	INPUTS WAITING TIME FAULT	System was unable to satisfy combustion air switch test and/or proof of closure during a burner sequence. Check wiring. Check air-flow switch.
38	SUPV SW WDT RESET	Internal software reset by Microcontroller. Contact distributor/factory if error persists.
39	SUPV SW RESET	Internal software reset by Microcontroller. Contact distributor/factory if error persists.
40	HARDWARE RESET	Replace control. Contact distributor/factory if error persists.
41	SUPV HARDWARE RESET	Replace control. Contact distributor/factory if error persists.
42	MAIN LOOP STUCK FAULT	Replace control. Contact distributor/factory.
43	SUPV LOOP STUCK FAULT	Replace control. Contact distributor/factory.
44	SUPV TIMER2 FAULT	Replace control. Contact distributor/factory.
45	MAIN AC PEAK MISSING FAULT	Check Mains voltage. Contact distributor/factory.
46	SUPV AC PEAK MISSING FAULT	Check Mains voltage. Contact distributor/factory.
47	UV PULSE INPUT MISMATCH	Replace control. Contact distributor/factory.
48	SUPERVISORY MCU ADC FAULT	Replace control. Contact distributor/factory.
49	MAIN MCU ADC FAULT	Replace control. Contact distributor/factory.
50	IGNITION FEEDBACK FAULT	System detected voltage on terminal 16 at the wrong time or voltage is not present when needed. Check wiring and make sure grounding is adequate.
51	PILOT_FEEDBACK_FAULT	System detected voltage on terminal 17 at the wrong time or voltage is not present when needed. Check wiring and make sure grounding is adequate.
52	MAINP_FEEDBACK_FAULT	System detected voltage on terminal 19 at the wrong time or voltage is not present when needed. Check wiring and make sure grounding is adequate.
53	FEEDBACK_WAITING_TIME_EXPIRE	Loss of actuator feedback for more than 10 minutes. Check wiring. Check modulation equipment.
54	MAIND_FEEDBACK_FAULT	System detected voltage on terminal 18 at the wrong time or voltage is not present when needed. Check wiring and make sure grounding is adequate.
55	INTERRUPT DIAG FAULT	Replace control. Contact distributor/factory.
56	FALSE_FLAME_ERROR	False flame detected before Ignition. Check wiring. Check scanner. Make sure grounding is adequate.
57	POWERON_FALSE_FLAME_ERROR	False flame detected at power on. Check wiring. Check scanner. Make sure grounding is adequate.
58	OPEN_FEEDBACK_READING_FAULT	System detected voltage on terminal 8 at the wrong time or voltage is not present when needed. Check wiring and make sure grounding is adequate.
59	ADJACENT PIN SHORT FAULT	Replace control. Contact distributor/factory.
60	LOCAL RESET DEBOUNCE FAULT	Local reset button held for more than 10 seconds or reset button is stuck.
61	POC OPEN FAULT	Fuel valve is open at the wrong time OR check wiring
62	STRONG UV FLAME FAULT	Scanner too close to flame. Add distance between scanner and flame OR use orifice to reduce field of view.
63	SPI CRC FAULT	Replace control. Contact distributor/factory



NOTICE

When Fireeye products are combined with equipment manufactured by others and/or integrated into systems designed or manufactured by others, the Fireeye warranty, as stated in its General Terms and Conditions of Sale, pertains only to the Fireeye products and not to any other equipment or to the combined system or its overall performance.

WARRANTIES

FIREYE guarantees for *one year from the date of installation or 18 months from date of manufacture* of its products to replace, or, at its option, to repair any product or part thereof (except lamps and photocells) which is found defective in material or workmanship or which otherwise fails to conform to the description of the product on the face of its sales order. **THE FOREGOING IS IN LIEU OF ALL OTHER WARRANTIES AND FIREYE MAKES NO WARRANTY OF MERCHANTABILITY OR ANY OTHER WARRANTY, EXPRESS OR IMPLIED.** Except as specifically stated in these general terms and conditions of sale, remedies with respect to any product or part number manufactured or sold by Fireeye shall be limited exclusively to the right to replacement or repair as above provided. In no event shall Fireeye be liable for consequential or special damages of any nature that may arise in connection with such product or part.



FIREYE®
3 Manchester Road
Derry, New Hampshire 03038 USA
www.fireeye.com

BP-1001
NOVEMBER 10, 2017
Supersedes October 24, 2017