



5-year warranty



Technical data

|                        |                                    |   |
|------------------------|------------------------------------|---|
| <b>Electrical data</b> | Nominal voltage                    | AC/DC 24 V  |
|                        | Nominal voltage frequency          | 50/60 Hz  |
|                        | Nominal voltage range              | AC 19.2...28.8 V / DC 21.6...28.8 V   |
|                        | Power consumption in operation     | 8 W   |
|                        | Power consumption in rest position | 4.5 W   |
|                        | Transformer sizing                 | 14 VA   |
|                        | Electrical Connection              | 18 GA appliance cable, 1 m, with 1/2" conduit connector                                     |
|                        | Overload Protection                | electronic throughout 0...95° rotation  |
|                        | Electrical Protection              | actuators are double insulated  |
| <b>Functional data</b> | Torque motor                       | 270 in-lb [30 Nm]   |
|                        | Operating range Y                  | 2...10 V  |
|                        | Operating range Y note             | 4...20 mA w/ ZG-R01 (500 Ω, 1/4 W resistor)   |
|                        | Input Impedance                    | 100 kΩ for 2...10 V (0.1 mA), 500 Ω for 4...20 mA   |
|                        | Position feedback U                | 2...10 V  |
|                        | Position feedback U note           | Max. 0.5 mA   |
|                        | Direction of motion motor          | selectable with switch 0/1  |
|                        | Direction of motion fail-safe      | reversible with cw/ccw mounting   |
|                        | Manual override                    | 5 mm hex crank (3/16" Allen), supplied  |
|                        | Angle of rotation                  | Max. 95°  |
|                        | Angle of rotation note             | adjustable with mechanical end stop, 35...95°   |
|                        | Running Time (Motor)               | 95 s / 90°  |
|                        | Running time fail-safe             | <20 s @ -4...122°F [-20...50°C], <60 s @ -22°F [-30°C]                                      |
|                        | Adaptation Setting Range           | manual, by two full cycles of 0/1 switch  |
|                        | Noise level, motor                 | 56 dB(A)  |
|                        | Noise level, fail-safe             | 71 dB(A)  |
| Position indication    | Mechanical                         |   |
| <b>Safety data</b>     | Power source UL                    | Class 2 Supply  |
|                        | Degree of protection IEC/EN        | IP54  |
|                        | Degree of protection NEMA/UL       | NEMA 2  |
|                        | Enclosure                          | UL Enclosure Type 2   |
|                        | Agency Listing                     | cULus acc. to UL60730-1A/-2-14, CAN/CSA E60730-1:02, CE acc. to 2014/30/EU                  |
|                        | Quality Standard                   | ISO 9001  |
|                        | UL 2043 Compliant                  | Suitable for use in air plenums per Section 300.22(C) of the NEC and Section 602 of the IMC |
|                        | Ambient humidity                   | Max. 95% RH, non-condensing   |
|                        | Ambient temperature                | -22...122°F [-30...50°C]  |

|                    |  |                                       |
|--------------------|--|---------------------------------------|
| <b>Safety data</b> | Storage temperature  | -40...176°F [-40...80°C]              |
|                    | Servicing  | maintenance-free                      |
| <b>Weight</b>      | Weight   | 12 lb [5.3 kg]                        |
| <b>Materials</b>   | Housing material   | Die cast aluminium and plastic casing |
| <b>Footnotes</b>   | †Rated Impulse Voltage 800V, Type of action 1.AA, Control Pollution Degree 3 |                                       |

**Product features**

**Application** For fail-safe, modulating control of dampers in HVAC systems. Actuator sizing should be done in accordance with the damper manufacturer's specifications. The actuator is mounted directly to a damper shaft up to 1.05" in diameter by means of its universal clamp. A crank arm and several mounting brackets are available for applications where the actuator cannot be direct coupled to the damper shaft. The actuator operates in response to a DC 2...10 V, with the addition of a 500Ω resistor, a 4...20 mA control input from an electronic controller or positioner. A DC 2...10 V feedback signal is provided for position indication.

A common installation technique for control of multi-section dampers is to use the U5 position feedback of one actuator (Primary) to control multiple actuators (Secondary). Belimo refers to this as primary and secondary control. The only requirement is that the actuators are installed on MECHANICALLY SEPARATE damper shafts.

**Operation** The EF..24-SR series actuators provide true spring return operation for reliable failsafe application and positive close off on air tight dampers. The spring return system provides constant torque to the damper with, and without, power applied to the actuator. The EF..24-SR series provides 95° of rotation and is provided with a graduated position indicator showing 0° to 95°. The EF..24-SR uses a brushless DC motor which is controlled by an Application Specific Integrated Circuit (ASIC) and a microprocessor. The microprocessor provides the intelligence to the ASIC to provide a constant rotation rate and to know the actuator's exact fail-safe position. The ASIC monitors and controls the brushless DC motor's rotation and provides a digital rotation sensing function to prevent damage to the actuator in a stall condition. The actuator may be stalled anywhere in its normal rotation without the need of mechanical end switches. The EF..24-SR actuator is shipped at 5° (5° from full fail-safe) to provide automatic compression against damper gaskets for tight shut-off.

Installation Note: Use flexible metal conduit. Push the UL listed conduit fitting device over the actuator's cable to butt against the enclosure. Screw in conduit connector. Jacket the actuator's input wiring with UL listed flexible conduit. Properly terminate the conduit in a suitable junction box.

**Typical specification** Spring return control damper actuators shall be direct coupled type which require no crank arm and linkage and be capable of direct mounting to a jackshaft up to a 1.05" diameter. The actuator must provide modulating damper control in response to a 2 to 10 VDC or, with the addition of a 500Ω resistor, a 4 to 20 mA control input from an electronic controller or positioner. The actuators must be designed so that they may be used for either clockwise or counter clockwise fail-safe operation. Actuators shall use a brushless DC motor controlled by a microprocessor and be protected from overload at all angles of rotation. Run time shall be constant, and independent of torque. A 2 to 10 VDC feedback signal shall be provided for position feedback. Actuators with auxiliary switches must be constructed to meet the requirements for Double Insulation so an electrical ground is not required to meet agency listings. Actuators shall be cULus listed and have a 5 year warranty, and be manufactured under ISO 9001 International Quality Control Standards. Actuators shall be as manufactured by Belimo.









**Adaptation and synchronisation** An adaption can be triggered by manually rotating the direction of rotation switch TWO full cycles. Adaption will detect the applications mechanical end stops by driving to each stop. An adaption will scale the control signal input, position feedback voltage, and running time to the new working mechanical angle of rotation. It is good practice to initiate an adaption on each actuator when mounting and controlling EF..SR.. actuators in Piggy-back mode.

If the manual override is used, with power applied, the actuator will perform a Synchronization upon release of the manual override hand crank. The actuator drives from the current control position to the synchronize reference of 0%. The actuator then drives back to the control position defined by the input signal.

**Accessories**

| Electrical accessories | Description   | Type     |
|------------------------|---|----------|
|                        | DC Voltage Input Rescaling Module   | IRM-100  |
|                        | Auxiliary switch, mercury-free  | P475     |
|                        | Auxiliary switch, mercury-free  | P475-1   |
|                        | Signal simulator, Power supply AC 120 V   | PS-100   |
|                        | Convert Pulse Width Modulated Signal to a 2...10 V Signal for Belimo                  | PTA-250  |
|                        | Proportional Actuators  |          |
|                        | Positioner for wall mounting  | SGA24    |
|                        | Positioner for front-panel mounting   | SGF24    |
|                        | Cable conduit connector 1/2"  | TF-CC US |
|                        | Resistor, 500 $\Omega$ , 1/4" wire resistor with 6" pigtail wires                     | ZG-R01   |
|                        | Resistor kit, 50% voltage divider   | ZG-R02   |
|                        | Transformer, AC 120 V to AC 24 V, 40 VA   | ZG-X40   |
| Mechanical accessories | Description   | Type     |
|                        | Shaft extension 240 mm $\varnothing$ 20 mm for damper shaft $\varnothing$ 8...22.7 mm | AV8-25   |
|                        | Anti-rotation bracket EFB(X)/GKB(X)/GMB(X).   | EF-P     |
|                        | End stop indicator  | IND-EFB  |
|                        | Shaft clamp reversible, clamping range $\varnothing$ 12...26.7 mm                     | K9-2     |
|                        | Ball joint suitable for damper crank arm KH8 / KH10, Multipack 10 pcs.                | KG10A    |
|                        | Damper crank arm Slot width 8.2 mm, clamping range $\varnothing$ 14...25 mm           | KH10     |
|                        | Actuator arm Slot width 8.2 mm  | KH-EFB   |
|                        | Push rod for KG10A ball joint 36" L, 3/8" diameter                                    | SH10     |
|                        | Wrench 0.512 in. [13 mm]  | TOOL-07  |
|                        | Mounting bracket for AF..   | ZG-100   |
|                        | Jackshaft mounting bracket.   | ZG-120   |
|                        | ZG-JSL support plate for EFB(X)   | ZG-121   |
|                        | Damper clip for damper blade, 3.5" width.   | ZG-DC1   |
|                        | Damper clip for damper blade, 6" width.   | ZG-DC2   |
|                        | Mounting kit for linkage operation for flat and side installation                     | ZG-EFB   |
|                        | 1.05" diameter jackshaft adaptor (12" L).   | ZG-JSA-3 |

**Electrical installation**

-  **Warning! Live electrical components!**  
During installation, testing, servicing and troubleshooting of this product, it may be necessary to work with live electrical components. Have a qualified licensed electrician or other individual who has been properly trained in handling live electrical components perform these tasks. Failure to follow all electrical safety precautions when exposed to live electrical components could result in death or serious injury.
-  Meets cULus requirements without the need of an electrical ground connection.
-  Actuators with appliance cables are numbered.
-  Provide overload protection and disconnect as required.
-  Actuators may also be powered by DC 24 V.
-  Only connect common to negative (-) leg of control circuits.
-  A 500  $\Omega$  resistor (ZG-R01) converts the 4...20 mA control signal to 2...10 V.
-  Actuators may be connected in parallel if not mechanically linked. Power consumption and input impedance must be observed.

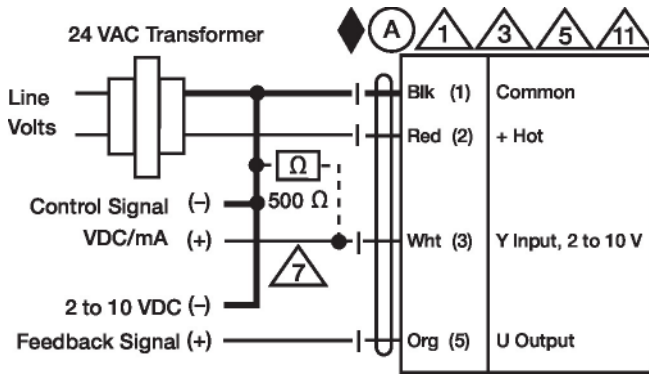

2...10 V / 4...20 mA Control

Dimensions

