



## RDY2000 Commercial Room Thermostat



Figure 1. RDY2000 Thermostat.

### Product Specifications

System Compatibility	
Conventional	Up to 3 Heating/3 Cooling stages
Heat Pumps	Up to 4 Heating/2 Cooling stages
Electrical Characteristics	
Power Supply	24 Vac +/-20%, Class 2, 4A max.
Power Usage	4 VA (maximum)
Output Relay Ratings	Pilot duty, 1A max. per output, 4A max total
Ambient Limitations	
Operating Temperature	23°F to 122°F (-5°C to 50°C)
Storage/Shipping Temperature	-13°F to 158°F (-25°C to 70°C)
Relative Humidity	Up to 95% (non-condensing)
Enclosure	
Rating	NEMA 1

**NOTE:** The RDY2000 is not battery-powered. It requires 24 Vac power from the HVAC equipment at terminals RH/RC and C.

### Product Number

RDY2000

### Caution Notations

<b>CAUTION:</b>		Equipment damage or loss of data may occur if you do not follow the procedures as specified.
-----------------	--	--

### Required Tools

- No. 1 Phillips screwdriver
- 1/8" flat-blade screwdriver
- Drill with 1/8" drill bit

### Expected Installation Time

15 minutes



#### CAUTION:

The RDY2000 is an advanced controller designed to be installed by professional HVAC technicians. Installation by non-qualified personnel may result in degraded system efficiency, occupant discomfort, or equipment damage.

### Prerequisites

- All work must be performed in accordance with applicable codes and standards.
- Use 18 gauge thermostat wire for equipment connections.
- 22 gauge shielded cable is recommended for remote sensor wiring. Do not exceed 150 feet.
- To replace an existing thermostat, verify if 24 Vac is present between the RH/RC and C terminals.
- Turn off power to the HVAC equipment before attempting to remove the existing thermostat.
- Record wiring connections to existing thermostat terminals.
- Remove the existing thermostat before proceeding.

### Installation

1. Install the thermostat base plate.
  - a. Feed the existing wires through the opening in the base plate.

- b. Secure the base plate to the mounting surface using supplied hardware.

**NOTE:** Ensure that the UP arrows embossed on the base plate are pointed upward.



**Figure 2. Thermostat Base Plate.**

**NOTE:** If 24 Vac was verified as being present at the thermostat wires (see *Prerequisites*), skip Step 2 and proceed to Step 3.

- 2. If 24 Vac is not present at the thermostat:
  - a. Locate the 24 Vac transformer or 24 Vac on the terminal strip on the HVAC unit. Attach a thermostat wire to the 24 Vac source. See the HVAC equipment schematics to verify the correct terminals.
  - b. Attach the other end of the unused wire to the thermostat RH or RC terminal.
  - c. Verify that 24 Vac is present between the RH/RC and C terminals.
- 3. Attach the existing wires to the appropriate terminals on the thermostat base plate. See *Wiring Diagrams*, Figure 4 and Figure 5.  
 (Optional): If using Auxiliary Inputs 1 to 4 or configurable outputs 1 to 3, use setup parameters P301 to P320 to set functionality.
- 4. For systems with dual transformers, do the following; otherwise, proceed to Step 5:  
 If separate transformers are used for heating and cooling systems, connect 24 Vac from the cooling system to RC, and 24 Vac from the heating system to RH. Remove Jumper RH-RC.  
 (Optional): Auxiliary Output 3 can be changed to a dry (unpowered) contact by removing Jumper RC-C3 See *Wiring Diagrams*, Figure 6.
- 5. Attach thermostat to the base plate by engaging tabs at the top and rotating the thermostat downward until it is securely seated on the base plate.

- 6. Secure the thermostat to the base plate with the Phillips screws (provided), using the holes at the bottom of the housing.

The installation is now complete. Restore power, and continue to *Thermostat Setup*.

### Thermostat Setup

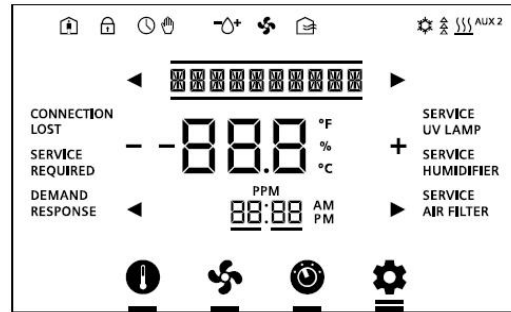

**Figure 3. Thermostat Display.**

### Thermostat Display

#### Navigation Bar

Only one function can be selected at a time. The small bar (cursor) below the function icon indicates that a function is selected. Pressing an icon twice navigates back to the Main screen.

A double bar cursor below the **Settings** [gear icon] indicates that you are in Programming mode.

The navigation bar at the bottom of the display consists of four function icons.











**Table 1. Navigation Bar Icons.**

Icon	Name	Purpose
	Setpoint	Enables adjustment of temperature and humidity (if applicable) setpoints. Unit will display heating setpoint if in Heating mode or cooling setpoint if in Cooling mode.
	Fan Control	Enables fan relay to be controlled as needed by thermostat (AUTO) or to be on continuously (ON).
	Mode Selector	Enables manual changeover between Heating and Cooling mode. AUTO will enable the thermostat to automatically switch between heating and cooling mode as required. OFF will disable all control functions.
	Settings	Enables Scheduler, Time/Date, and Installer Set Up configuration. Also enables access to service reminder and fault messages.

## Status Bar

The status bar at the top of the display consists of 11 icons.

**Table 2. Status Bar Icons.**

Icon	Name	Meaning
	Occupied	Space is occupied, based on Schedule and/or Occupancy Sensor.
	Keypad Lock	Keypad is locked.
	Scheduler	Unit is running on the local schedule.
	Override	The Scheduler is being overridden by local control.
	Humidity Control Indicator	Droplet and (+) indicates humidification relay is on. Droplet and (-) indicates dehumidification relay is on. If neither relay is on, the water droplet does not appear.
	Fan	Fan relay is on.
	Fresh Air	Economizer Enable/ Ventilation relay is on.
	Cool Mode	The system is actively in cooling mode.
	Heat Mode	The system is actively in heating mode.
	Heating/Cooling Stages	Each segment represents one stage of heating or cooling.
<b>AUX 2</b>	Auxiliary Heating	Auxiliary heating stage: AUX=Stage 1: Aux 2=Stage 2

## Service Reminders and Fault Messages

- Service reminders appear at the right side of the screen:
  - SERVICE UV LAMP
  - SERVICE HUMIDIFIER
  - SERVICE AIR FILTER

They are determined by the timer set in the Installer Setup Menu, and can be cleared by pressing the

**Settings** [] icon, and then **SERVICE**. See *Clearing Service Reminders*.

- Active fault messages appear at the left side of the home screen:
  - CONNECTION LOST (Not applicable to this model)
  - DEMAND RESPONSE (Not applicable to this model)
  - SERVICE REQUIRED (See *Viewing Fault Messages*)

Fault messages are automatically cleared when the root cause of the failure is resolved.

## Wiring Diagrams

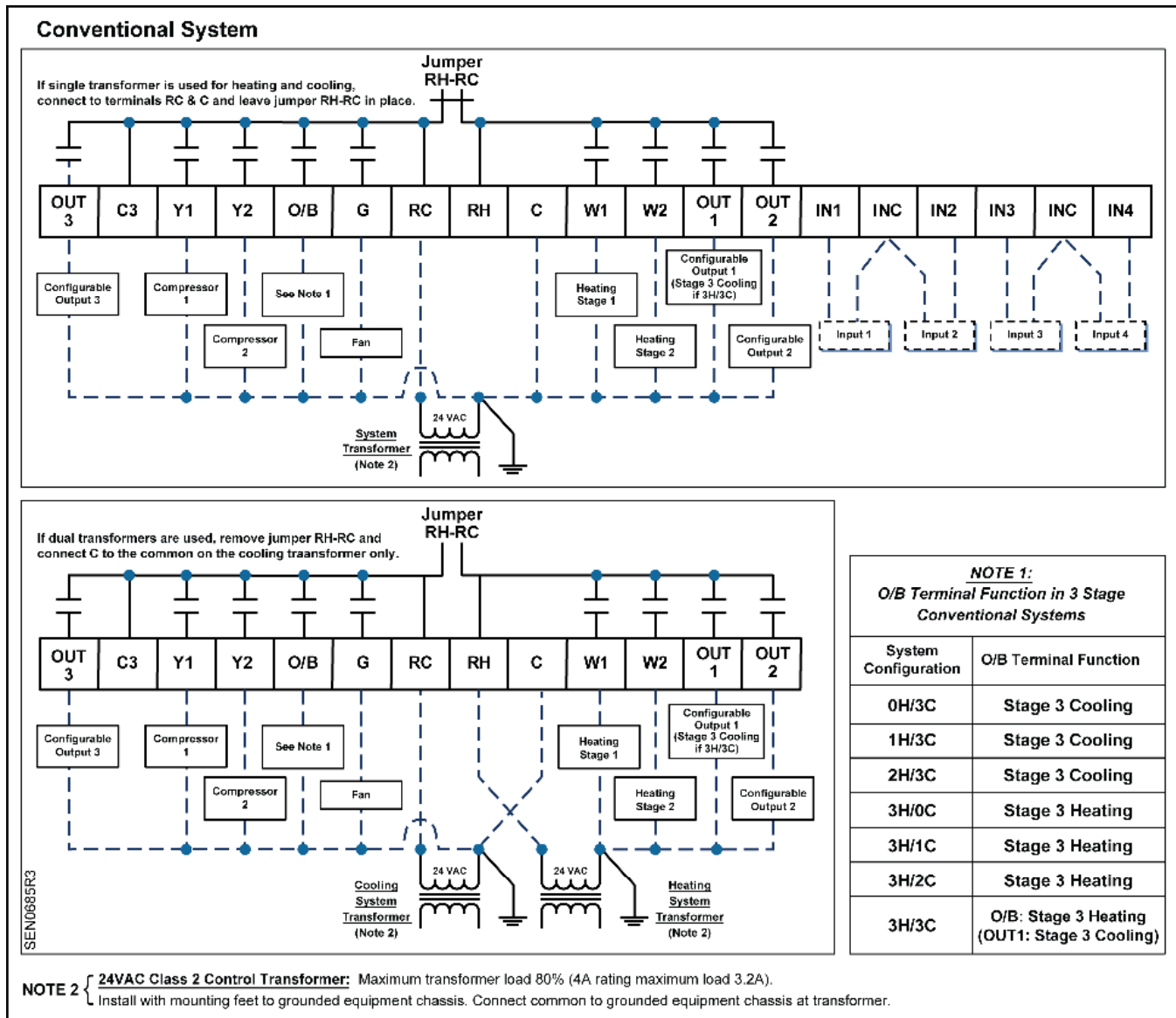

Figure 4. Wiring Schematic, Conventional System.

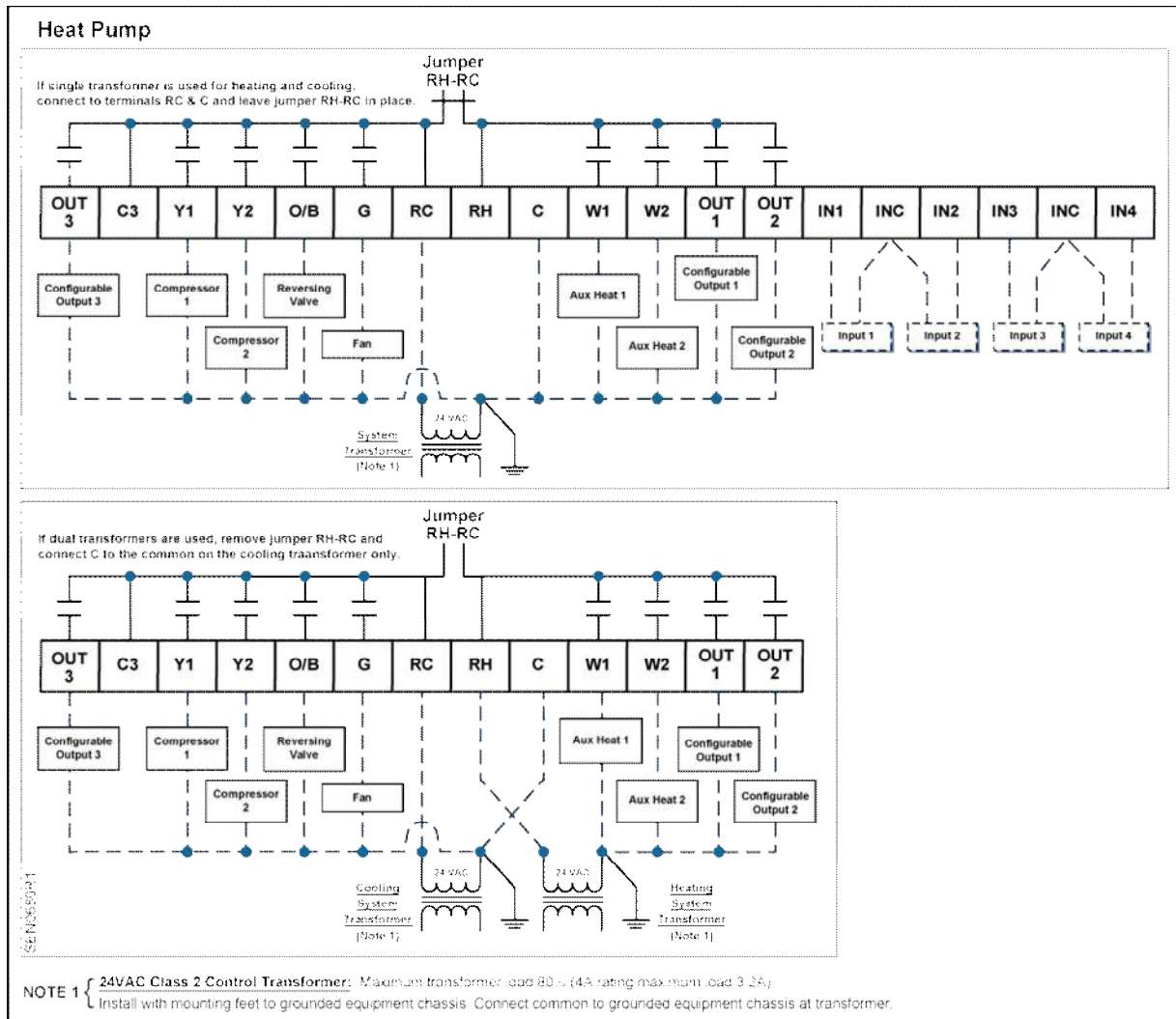

Figure 5. Wiring Schematic, Heat Pump.

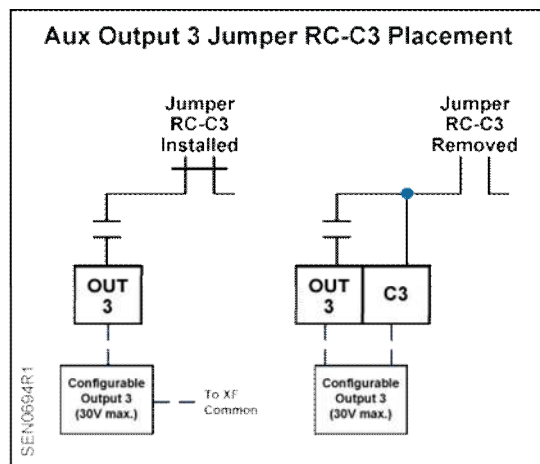



Figure 6. Wiring Schematic, Aux Output 3.

## Set-up Wizard

When the unit is powered up for the first time, **WIZARD** displays. This tool is used to program the basic system parameters. Additional parameters can be accessed directly via the Installer/Expert Set-up menus.

**NOTE:** The thermostat will not start the control sequence until the Set-up Wizard is complete.

1. Press **WIZARD** to access the menu.
2. Press **+** or **-** to change parameter settings, and then use left and right arrows to select the additional parameters.
3. After verifying all parameters, press **Confirm** to save and complete.
4. **INSTALLER** displays. If setup is complete, press the **Settings** [  ] icon to exit the Set-up Wizard. If further setup is needed, continue to Step 6.
5. Press **INSTALLER** to access the Installer Menu and more detailed setup. See Table 3 through Table 7 for all parameter descriptions.
6. Use the space provided in Table 15 to record modified parameter settings.
7. Press the **Settings** [  ] icon when finished to exit setup.



## Programming Temperature Setpoints

1. Touch the center of the Home screen to access the room temperature screen. Use the left [ ] and right [ ] arrows adjacent to the text line to display the room temperature and humidity.
2. Touch the **Setpoint** [  ] icon of the screen to access room temperature and humidity setpoints.

**NOTE:** Only the setpoints in the current mode display and can be modified. For instance, if the thermostat is in heating mode, only the heating setpoint displays and can be modified. If the thermostat is in AUTO mode, both the heating and cooling setpoints will be displayed and can be modified.
3. Use the left [ ] and right [ ] arrows to access the different setpoints, and the **+** and **-** icons to adjust the setpoints.
4. Touch the center of the screen to exit Setpoint Programming.

**NOTE:** If the screen is not touched for 10 seconds, the unit returns to the Home screen.

## Programming Time and Date

1. Touch the center of the Home screen.
2. Press the **Settings** [  ] icon. **SCHEDULER** displays.
3. Use the left [ ] and right [ ] arrows to access the Time menu. Press **TIME**. Press the two-digit hour display to change the hour, or press the two-digit minute display to change the minutes. Press the left arrow to decrease the value, and the right arrow to increase the value.
4. Press the **Settings** [  ] icon to save.
5. Use the left [ ] and right [ ] arrows to access the Date menu. Press **DATE**. Use the arrows to select the month and year; use +/- to set the date.
6. Press the **Settings** [  ] icon to save.

## Installer Menu

1. Touch the center of the Home screen.
2. Press the **Settings** [  ] icon. **SCHEDULER** displays.
3. Press the left arrow [ ].
4. Press **INSTALLER**.
5. Using the lower left [ ] and right [ ] arrows, enter the password.
6. Press **PASSWORD** to accept the password.

**NOTE:** The Installer Level default password is **00:00**
7. Press the **Settings** [  ] icon to accept changes and return the unit to the Home screen.

**NOTE:** If you do not provide input, the thermostat will automatically exit the Installer menu and resume normal system control after five minutes.



## Programming the Schedule

1. Touch the center of the Home screen.
2. Press the **Settings**  icon. **SCHEDULER** displays.
3. Press **SCHEDULER**.
4. Use the left [ ] and right [ ] arrows to select the day. Press the **day** to select.
5. Use the + and – icons to set the temperature setpoints.
6. Use the left [ ] and right [ ] arrows to adjust the start time for each programming period. After selecting the start time, confirm by touching above the temperature display before moving to the next programming period.
7. Depending on the setting on the Scheduler (Parameter 107 – 108), set the schedule for each period. See Table 10 through Table 13 for default schedules.

## Resetting the Unit to Factory Defaults



### CAUTION:

The following steps set **ALL** parameters to factory defaults (including passwords), and restart the Set-up Wizard.

1. Log in as either an Installer or Expert.
2. Press the left [ ] arrow. **RESTORE** displays.
3. Press + to change the setting to **YES**.
4. Press **RESTORE**.



This resets the unit and restarts the Set-up Wizard.

## Maintenance

### Locking/Unlocking the Touch Screen

To prevent unauthorized access to thermostat settings, use Parameter P211 to configure screen

lockouts. The lock  icon indicates that the screen is locked. To unlock the keypad, do the following:

1. Touch the center of the Home screen to access the room temperature screen.
2. Press the **Settings**  icon once and **LOCKED** displays.
3. Press and hold the **Settings**  icon for 5 seconds; **PASSWORD** displays.

4. Using the lower left [ ] and right [ ] arrows, enter the **INSTALLER** password.
5. Press **PASSWORD** to accept the password.
6. Set Parameter 211 (Keypad Lockout) to zero to disable keypad lockout.
7. Touch the **Setpoint**  icon of the screen to return to the Home screen.

### Clearing Service Reminders

The thermostat displays **SERVICE REQUIRED** and an associated service reminder if the reminder timer (Parameters 208 - 210) has timed out. To clear these, do the following:

1. Touch the center of the Home screen to access the room temperature screen.
2. Press the **Settings**  icon and **SERVICE** displays.
3. Use the left [ ] and right [ ] arrows to select the service reminder.
4. To clear, touch the + icon and the display changes from “-----” to **OFF**.
5. Counter resets and reminder icons turn off.

### Viewing Fault Messages

The thermostat displays **SERVICE REQUIRED** if a sensor fails or a service reminder has timed out. To view these, do the following:

1. Touch the center of the Home screen to access the room temperature screen.
2. Press the **Settings**  icon and **SERVICE** displays.
3. Press **SERVICE** and review faults. Use the left [ ] and right [ ] arrows to see all faults.

**NOTE:** The fault message is automatically cleared when the root cause of the failure is resolved.

Table 3. 100 Series Parameters\*

Parameter	Definition	Display	Value Range	Default	Extended Definition	Notes
P101	System Type	SYS TYPE	CO HP	CO	CO = Conventional System HP = Heat Pump	
P102	Cooling Stages	COOL STGS	0 1 2 3	2	Sets number of cooling stages.	
P103	Heating Stages	HEAT STGS	0 1 2 3	2	Sets number of heating stages.	
P104	Aux Heating Stages	AUX HT STG	0 1 2	0	Sets number of auxiliary heat stages available for heat pump control.	This parameter only appears if P101 = HP.
P105	Fan Operation	HTG FAN	NO YES	NO (YES if P101=HP)	YES = Fan Relay energized by thermostat on call for heat NO = Fan relay not energized by thermostat on call for heat	If HVAC unit does not start fan on call for heat, set P105 to YES.
P106	Reversing Valve	REV VALVE	O B	O	O = Energize reversing valve on cooling B = Energize reversing valve on heating	This parameter only appears if P101 = HP.
P107	Scheduler Days	SCHEDULER	0 1 2 3 7	2	0 = Disable Scheduler 1 = Schedule all days with same schedule 2 = One schedule for M-F and another for Sat + Sun 3 = One schedule for M-F, Sat + Sun scheduled individually 7 = Schedule each day individually	See Table 9 through Table 13.
P108	Program Periods	PERIODS	2 4	2	Sets number of program periods per day: 2 = 2 periods (Day/Night) 4 = 4 periods (Wake/Day/Evng/Night)	This parameter only appears if P107 > 0.
P109	Units	UNITS	F C	F	<b>NOTE:</b> Changing temperature units will reset all temperature-related parameters to their default values.	
P110	Auto Change	AUTO CHNGE	YES NO	YES	Enables auto change between heating and cooling.	This parameter does not appear on systems that are heat only or cool only.
P111	Changeover Deadband	DEADBAND	3°F to 9°F (2.0°C to 5.0°C)	5°F (3.0°C)	Changeover deadband in degrees F (C)	This parameter does not appear if P110 = NO.  This parameter forces a separation between heating and cooling setpoints to prevent short cycling of heating/cooling cycles.
P112	Daylight Savings	DAYLT SAVE	NO YES	YES	Y = Auto adjust for Daylight Savings Time N = Does not auto adjust for Daylight Savings Time	Daylight Savings Time adjustment is based on USA schedule.

\* Included in Set-up Wizard



Table 4. 200 Series Parameters.

Parameter	Definition	Display	Value Range	Default	Extended Definition	Notes
P201	Heat Temp Limit	HEAT LIMIT	45°F to 95°F (7.0°C to 35.0°C)	95°F (35.0°C)	Sets maximum allowable heating set point.	Does not appear if P103 = 0.
P202	Cool Temp Limit	COOL LIMIT	50°F to 95°F (10.0°C to 35.0°C)	50°F (10.0°C)	Sets minimum allowable cooling set point.	Does not appear if P102 = 0.
P203	Temperature Display Offset	TMP OFFSET	-5°F to 5°F (-3.0°C to 3.0°C)	0°F (0°C)	Enables adjustment of control temp and display temperature in 1 degree increments. Applies only to onboard temp sensor. Indoor temp only.	
P204	Override Time Limit	HRS OVR RD	0 to 96 hours	---	Number of hours that scheduled setpoint can be manually overridden. 0 = No override allowed --- = Unlimited	This parameter will not appear if P107 = 0.
P205	Override Temp Limit	TMP OVR RD	1°F to 10°F (0.5°C to 4.0°C)	---	Number of degrees that are allowed above or below scheduled setpoint. --- = Unlimited	This parameter will not appear if P107 or P204 = 0.
P206	Heat Pump Compressor Lock Out	HP COMP LO	OFF 15°F (-9.0°C) 20°F (-6.0°C) 25°F (-3.0°C) 30°F (-1.0°C) 35°F (1.0°C) 40°F (4.0°C) 45°F (7.0°C)	OFF	Heat pump compressor will not operate below this outdoor temp -- forcing unit to auxiliary heat. An outdoor temperature sensor is required. <b>NOTE:</b> If P206 ≠ OFF, set P508 = 1°F (0.5°C).	This parameter only appears for the following conditions: - P101 = HP. - P104 > 0. - P105 = YES - P301, P305, P309, or P313=5 - P206 < P207.
P207	Heat Pump Auxiliary Heat Lockout	HP AUX LO	OFF 40°F (4.0°C) 45°F (7.0°C) 50°F (10.0°C) 55°F (13.0°C) 60°F (16.0°C)	OFF	Heat pump auxiliary heat will not operate above this outdoor temp. An outdoor temperature sensor is required.	This parameter only appears for the following conditions: - P101 = HP. - P104 > 0. - P301, P305, P309, or P313 = 5 - P207 > P206.
P208	Service UV Lamp	UV LAMP	0 to 365 days	0	Number of calendar days until SERVICE UV LAMP message displays. 0 = function disabled.	
P209	Service Humidifier	HMDFR SRVC	0 to 365 days	0	Number of calendar days until SERVICE HUMIDIFIER message displays. 0 = function disabled.	
P210	Service Air Filter	FLTR SRVC	0 to 365 days	0	Number of calendar days until SERVICE AIR FILTER message displays. 0 = function disabled.	
P211	Keypad Lockout	KEY LOCK	0 = NONE 1 = PARTIAL 2 = FULL	0	0 = No Lockout 1 = Partial Lockout (only temp setpoint can be adjusted) 2 = Total Lockout	Keypad lock  icon displays if P211 > 0.
P212	Clock Format	CLOCK	12 24	12	12 = 12-hour format 24 = 24-hour format	
P213	Backlight	LIGHT	0 to 99 seconds	15	Number of seconds that backlight stays on after screen is touched. 0 = Always off.	

Table 5. 300 Series Parameters.

Parameter	Definition	Display	Value Range	Default	Extended Definition	Notes
P301	Configurable Input 1 (IN1)	INPUT 1	0 1 2 3 4 5 6 7 8 9	0	0 = Not Used 1 = Indoor Temperature (Remote) 2 = Indoor Temperature (Average) 3 = Supply Temp 4 = Return Temp 5 = Outdoor Temp 6 = Humidity (0-10V) 7 = CO2 (0-10V) 8 = Occupancy (DI) 9 = Fault	- Selections for inputs 1 - 4 cannot be duplicated. - If set to 9 (fault), a DI here causes SERVICE REQUIRED segment to activate. - See Table 14 for a list of optional sensors approved for use with the RDY2000.
P302	Temperature Input 1 Type	TMP IN 1	0 1	0	0 = Type 2 Thermistor 1 = 0-10V	Only appears if P301 = 1/2/3/4/5.
P303	Temperature Input 1 Low	TMP 1 LO	-58°F to 120°F ** (-50.0°C to 50.0°C)	0°F (-18.0°C)	Calibrates thermostat to low end of temp sensor signal (for example, 0V = -40°F [4.4°C])	- Only appears if P302 = 1 ** P303 < P304.
P304	Temperature Input 1 High	TMP 1 HI	P303 value ** to 250°F (120.0°C)	120°F (50.0°C)	Calibrates thermostat to high end of temp sensor signal at 10 volts (for example, 10V = 250°F [120.0°C])	- Only appears if P302 = 1. ** P304 > P303.
P305	Configurable Input 2 (IN2)	INPUT 2	0 1 2 3 4 5 6 7 8 9	0	0 = Not Used 1 = Indoor Temperature (Remote) 2 = Indoor Temperature (Average) 3 = Supply Temp 4 = Return Temp 5 = Outdoor Temp 6 = Humidity (0-10V) 7 = CO2 (0-10V) 8 = Occupancy (DI) 9 = Fault	- Selections for Inputs 1 - 4 cannot be duplicated. - If set to 9 (fault), a DI causes SERVICE REQUIRED segment to activate - See Table 14 for a list of optional sensors approved for use with the RDY2000.
P306	Temperature Input 2 Type	TMP IN 2	0 1	0	0 = Type 2 Thermistor 1 = 0 to 10V	Only appears if P305 = 1/2/3/4/5.
P307	Temperature Input 2 Low	TMP 2 LO	-58°F to 120°F ** (-50.0°C to 50.0°C)	0°F (-18.0°C)	Calibrates thermostat to low end of temp sensor signal (for example, 0V = -40°F)	- Only appears if P306 = 1. ** P307 < P308
P308	Temperature Input 2 High	TMP 2 HI	P307 value ** to 250°F (120.0°C)	120°F (50.0°C)	Calibrates thermostat to high end of temp sensor signal at 10 volts (for example, 10V = 250°F).	- Only appears if P306 = 1. ** P308 > P307.
P309	Configurable Input 3 (IN3)	INPUT 3	0 1 2 3 4 5 6 7 8 9	0	0 = Not Used 1 = Indoor Temperature (Remote) 2 = Indoor Temperature (Average) 3 = Supply Temp 4 = Return Temp 5 = Outdoor Temp 6 = Humidity (0 to 10V) 7 = CO2 (0 to 10V) 8 = Occupancy (DI) 9 = Fault	- Selections for Inputs 1 - 4 cannot be duplicated. - If set to 9 (fault), a DI here causes SERVICE REQUIRED segment to activate. - See Table 14 for a list of optional sensors approved for use with the RDY2000.
P310	Temperature Input 3 Type	TMP IN 3	0 1	0	0 = Type 2 Thermistor 1 = 0-10V	Only appears if P309 = 1/2/3/4/5.

Parameter	Definition	Display	Value Range	Default	Extended Definition	Notes
P311	Temperature Input 3 Low	TMP 3 LO	-58°F to 120°F ** (-50.0°C to 50.0°C)	0°F (-18.0°C)	Calibrates thermostat to low end of temp sensor signal (Example: 0V = -40°F).	- Only appears if P310 = 1. ** P311 < P312.
P312	Temperature Input 3 High	TMP 3 HI	P311 value ** to 250°F (120.0°C)	120°F (50.0°C)	Calibrates thermostat to high end of temp sensor signal at 10 volts (for example, 10V = 250°F).	- Only appears if P310 = 1. ** P312 < P311.
P313	Configurable Input 4 (IN4)	INPUT 4	0 1 2 3 4 5 6 7 8 9	0	0 = Not Used 1 = Indoor Temperature (Remote) 2 = Indoor Temperature (Average) 3 = Supply Temp 4 = Return Temp 5 = Outdoor Temp 6 = Humidity (0 to 10V) 7 = CO2 (0 to 10V) 8 = Occupancy (DI) 9 = Fault	- Selections for Inputs 1 - 4 cannot be duplicated. - If set to 9 (fault), a DI here causes SERVICE REQUIRED segment to activate. - See Table 14 for a list of optional sensors approved for use with the RDY2000.
P314	Temperature Input 4 Type	TMP IN 4	0 1	0	0 = Type 2 Thermistor 1 = 0 to 10V	Only appears P313=1/2/3/4/5.
P315	Temperature Input 4 Low	TMP 4 LO	-58°F to 120°F ** (-50.0°C to 50.0°C)	0°F (-18.0°C)	Calibrates thermostat to low end of temp sensor signal (for example, 0V = -40°F [4.4°C]).	- Only appears if P314 = 1. ** P315 < P316.
P316	Temperature Input 4 High	TMP 4 HI	P315 value ** to 250°F (120.0°C)	120°F (50.0°C)	Calibrates thermostat to high end of temp sensor signal at 10 volts (for example, 10V = 250°F [121.1°C]).	Only appears if P314 = 1. ** P316 > P315.
P317	Aux Output 1 (OUT1)	AUX OUT 1	0 1 2 3 4 5	0	0 = Not Used 1 = Humidification 2 = Dehumidification 3 = Occupied 4 = Air Quality 5 = Economizer Enable	- Selections for Outputs 1 - 3 cannot be duplicated. - Air Quality not an option unless P301, P305, P309, or P313 = 7. - If system is conventional with 3H +3C, AO1 is fixed as Stage 3 cooling.
P318	Aux Output 2 (OUT2)	AUX OUT 2	0 1 2 3 4 5	0	0 = Not Used 1 = Humidification 2 = Dehumidification 3 = Occupied 4 = Air Quality 5 = Economizer Enable	-- Selections for Outputs 1 - 3 cannot be duplicated. - Air Quality is not an option unless P301, P305, P309, or P313 = 7.
P319	Aux Output 3 (OUT3 & C3)	AUX OUT 3	0 1 2 3 4 5	0	0 = Not Used 1 = Humidification 2 = Dehumidification 3 = Occupied 4 = Air Quality 5 = Economizer Enable	- Selections for Outputs 1 - 3 cannot be duplicated. - Air Quality is not an option unless P301, P305, P309, or P313 = 7.
P320	Independent Humidity Control	IND HMDTY	Yes No	No	Yes = Humidification/dehumidification relays can be energized independent of heating/cooling relays. No = Humidification/dehumidification relays are only energized if heating or cooling relay is energized.	Select <b>YES</b> to activate humidity control systems regardless of whether there is a need for heating or cooling.

Table 6. 400 Series Parameters.

Parameter	Definition	Display	Value Range	Default	Extended Definition	Notes
P401	Unit Number	UNIT NMBR	1 to 999	---	Allows HVAC unit number to be displayed on thermostat home screen.	
P402	CO2 Setpoint	CO2 SET PT	500 to 2000 PPM	800	If CO2 level, as measured by an external sensor exceeds setpoint, the Ventilation sequence is initiated.	For optimum human performance, CO2 levels should be kept below 1000 parts per million.
P403	Pre-Occupancy Purge	PRE OC PRG	0 1 2 3 hours	0	0 = Disabled 1 = 1 Hour 2 = 2 Hours 3 = 3 Hours	Pre-Occupancy Purge will energize the Economizer Enable and Fan relays prior to the start of the first scheduled occupancy period. Not applicable to systems without a schedule.
P404	Occupancy Sensor Min Run Timer	OCC MRT	3 to 60 minutes	30	Minimum run time to remain in Occupied mode upon receipt of signal from Occupancy Sensor.	Only shown if an input is set to Occupancy Sensor.
P405	Semi-Continuous Fan	CONT FAN	No Yes	NO	Fan relay will be continuously energized when space is occupied, as determined by schedule or external Occupancy Sensor.	Only shown if a schedule is present or if an input is configured for Occupancy Sensor.
P407	Installer Password	INSTALL PW	00:00 to 49.99	00:00	<b>NOTE:</b> If Installer Password is changed, a new password should be recorded for future reference.	
P701	Firmware Revision	FIRMWARE	X.X	N/A	Read Only	

### Expert Level Menus

1. Touch the center of the Home screen.
2. Press the **Settings**  icon. SCHEDULER displays.
3. Press the left [ ] arrow.
4. Press **INSTALLER**.
5. Using the lower left [ ] and right [ ] arrows, enter the password.
6. Press **PASSWORD** to accept the password and return the unit to the Setup Menu.

**NOTE:** The Expert Level default password is **99:99**.

7. See Table 3 through Table 8 and *Wiring Diagrams* for additional information.
8. Press the **Settings**  icon to accept changes and return the unit to the Home screen.

### Recovering a Lost Password

If either of the default passwords is changed, the new password(s) should be recorded and maintained for future reference. If the records are misplaced, the following procedure can be used to set new passwords:

1. Cycle power to the thermostat. This can be done by loosening the securing screws on the bottom of the housing and momentarily separating the thermostat from the base plate.
2. Within 50 seconds of restoring power, navigate to the Installer Set-up screen and enter **98:21** as the passcode.
3. The thermostat will go directly to the Expert Level password screen. A new Expert Level password can now be set.
4. After setting a new Expert Level password, the thermostat will return to the Home screen.
5. The new Expert Level password can be used to enter the full Expert Level set-up menu where both the Expert Level and Installer Level passwords can now be set to new values.

**Table 7. 500 Series Expert Settings Parameters.**  
 (Only available if logged in as an Expert.)

**NOTE:** P500 Series parameters are factory-set for optimum system performance. Changing these settings may degrade efficiency and/or compromise occupant comfort.

Parameter	Definition	Display	Value Range	Default	Extended Definition
P501	Stage Delay - Cooling	STG DLY CL	1 to 10 minutes	2	Time delay before next stage of cooling will be activated.
P502	Stage Differential - Cooling	STG DIF CL	1°F (0.5°C) to 10°F (5.0°C)	1°F (0.5°C)	Degrees above cooling deadband before Stage Delay timer is initiated.
P503	Cooling Minimum Off Time	M O T CL	1 to 10 minutes	3	Minimum time between compressor starts.
P504	Cooling Minimum On Time	M R T CL	1 to 10 minutes	5	Minimum run time for any stage of cooling.
P505	Changeover Delay	C-O DLY	1 to 60	3	Delay in minutes before system will automatically switch from heating to cooling (or vice versa).
P506	Cooling Deadband	CL DEADBND	1°F (0.5°C) to 5°F (4.0°C)	1°F	The deadband is divided equally above and below setpoint. Cooling will begin when temperature exceeds upper point of deadband and ceases when temperature falls below lower point of deadband.
P507	Stage Delay - Heating	STG DLY HT	1 to 10 minutes	2	Time delay before next stage of heating will be activated.
P508	Stage Differential - Heating	STG DIF HT	1°F (0.5°C) to 5°F (5.0°C)	Conv. = 1°F (0.5°C) HP = 2°F (1.0°C)	Degrees below heating deadband before Stage Delay timer is initiated. <b>NOTE:</b> If P206 ≠ OFF, set P508 = 1°F (0.5°C)
P509	Heating Minimum Off Time	M O T HT	1 to 10 minutes	5	Minimum time between heating starts.
P510	Heating Minimum On Time	M R T HT	1 to 10 minutes	Conv = 3 HP = 10	Minimum run time for any stage of heating.
P511	Heating Deadband	HT DEADBND	1°F (0.5°C) to 5°F (4.0°C)	1°F (0.5°C)	The deadband is divided equally above and below setpoint. Heating will begin when temperature falls below lower point of deadband and ceases when temperature rises above upper port of deadband.

**Table 8. 900 Series Expert Settings Parameters.**  
 (Only available if logged in as an Expert.)



**CAUTION:**

P900 Series parameters are used by professional HVAC technicians during the system commissioning process. Interlocks and time delays are defeated while using P900 parameters. Use of these parameters by non-qualified personnel may result in equipment damage.

Parameter	Definition	Display	Value Range	Default	Extended Definition
P901	Test Compressor 1	Y1 TEST	ON OFF	OFF	OFF = Relay not energized ON = Relay energized
P902	Test Compressor 2	Y2 TEST	ON OFF	OFF	OFF = Relay not energized ON = Relay energized
P903	Test Reversing Valve	O/B TEST	ON OFF	OFF	OFF = Relay not energized ON = Relay energized
P904	Test Fan	G TEST	ON OFF	OFF	OFF = Relay not energized ON = Relay energized
P905	Test Heat Stg 1	W1 TEST	ON OFF	OFF	OFF = Relay not energized ON = Relay energized
P906	Test Heat Stg 2	W2 TEST	ON OFF	OFF	OFF = Relay not energized ON = Relay energized
P907	Test Output 1	OUT1 TST	ON OFF	OFF	OFF = Relay not energized ON = Relay energized
P908	Test Output 2	OUT2 TST	ON OFF	OFF	OFF = Relay not energized ON = Relay energized
P909	Test Output 3	OUT3 TST	ON OFF	OFF	OFF = Relay not energized ON = Relay energized
P911	Expert Password	XPRT PW	50:00 to 99:99	99:99	

**Auxiliary Sequences**

The RDY2000 primary sequences are designed to control single and multi-stage heating/cooling systems to maintain a user-selected temperature setpoint.

The following auxiliary sequences are available to optimize occupant comfort and system efficiency:

**Humidification**

*Parameters*

- P317/ P318/P319: One of these must be set to 1
- P320: NO (default) = Humidification will only occur if there is a call for heating. YES = Humidification relay will be energized independently of heating and cooling relays.

- Humidity Setpoint: User-adjustable to desired level in humidification mode.

Sensors: Onboard humidity sensor or optional remote humidity sensor.

The humidification relay will energize when measured humidity drops approximately 4% below setpoint and will de-energize when measured humidity reaches setpoint. Deadbands and proof timers are in force to prevent short cycling.

## Dehumidification

### Parameters

- P317/ P318/P319: One of these must be set to **2**
- P320: NO (default) = Dehumidification will only occur if there is a call for cooling. YES = Dehumidification relay will be energized independently of heating and cooling relays.
- Dehumidity Setpoint: User adjustable to desired level in dehumidification mode.

Sensors: Onboard humidity sensor or optional remote humidity sensor.

The dehumidification relay will energize when measured humidity rises approximately 4% above setpoint and will de-energize when measured humidity reaches setpoint. Deadbands and proof timers are in force to prevent short cycling

## Economizer Enable

### Parameters

- P317/P318/P319: One of these must be set to **5**.
- P301/P305/P309/P313: One of these must be set to **8** if the optional occupancy sensor is used.

Sensors: None required, however an optional occupancy sensor can be used instead of, or in conjunction with the scheduler to determine occupancy.

The Economizer Enable relay will be energized whenever a cooling relay is energized or the space is occupied. The thermostat will use the scheduled setpoints to predict when space is occupied. An optional occupancy sensor can also be used for definitive proof of occupancy.

An output configured for Occupancy Notification can also be used for Economizer Enable.

## Pre-Purge

### Parameters

- P317/P318/P319: One of these must be set to **5**.
- P403

Sensors: None required.

To enable the economizer and energize the fan relay prior to scheduled occupancy, set P403 to the number of hours before scheduled occupancy for pre-purge to begin. This function requires a schedule to be configured.

## Occupancy Notification

### Parameters

- P301/P305/P309/P313: If the optional occupancy sensor is used, one of these must be set to **8**.
- P317/P318/P319: To signal an external device that the space is occupied, one of these must be set to **3**
- P404: If the optional occupancy sensor is used, P404 can be used to set a minimum run timer for any actions that are activated by occupancy, such as Economizer Enable, control to occupied temperature setpoints, and so on. Note that many occupancy sensors also have onboard proof timers.

There are two primary methods by which the thermostat can assume the space is occupied.

1. In Cooling mode, it will assume that scheduled periods with lower setpoint(s) indicate occupancy. In Heating mode, it will assume occupancy during periods of higher setpoints.
2. During periods in which the schedule indicates the space is unoccupied, any human interaction with the thermostat (for example, setpoint adjustment) will put the thermostat into Occupied mode.

The optional occupancy sensor can be used in conjunction with the schedule. The thermostat will follow the assumptions above, but an input from the occupancy sensor during a scheduled unoccupied period will put the thermostat in the Occupied mode for the duration of the timer set in P404.

To utilize the Occupancy functions, the thermostat must have an active schedule.

## Air Quality Management

### Parameters

- P301/P305/P309/P313: One of these must be set to **7**.
- P317/P318/P319: One of these must be set to **4**.
- P402: CO2 Setpoint

Sensors: Optional CO2 Sensor

- If measured CO2 exceeds the setpoint by 200 PPM, the Air Quality output and fan relays will be energized. The minimum run time is 5 minutes.
- When measured CO2 falls below the setpoint and appropriate minimum run time has been met, the Air Quality output relay will be de-energized and the fan relay shall revert to normal operation.



**Table 9. Single Schedule.**

Day	2 Periods Per Day		4 Periods Per Day			
	Day	Night	Wake	Day	Evng	Night
Setpoint Heat, °F	70	62	70	62	70	62
Setpoint Cool, °F	75	82	75	78	75	82
Time	6:00 AM	10:00 PM	6:00 AM	11:00 AM	1:00 PM	10:00 PM

**NOTE:** Daily Schedule – 2 periods per day: Parameter 107 = 1; Parameter 108 = 2  
 Daily Schedule – 4 periods per day: Parameter 107 = 1; Parameter 108 = 4; Parameter 109 = F

**Table 10. Work Week Schedule with Weekend.**

Day	NOTE: 2 Periods per Day (Factory Default) Parameter 107 = 2; Parameter 108 = 2; Parameter 109 = F				NOTE: 4 Periods per Day Parameter 107 = 2; Parameter 108 = 4; Parameter 109 = F							
	Work Week (Monday-Friday)		Weekend (Saturday-Sunday)		Work Week (Monday-Friday)				Weekend (Saturday-Sunday)			
	Day	Night	Day	Night	Wake	Day	Evng	Night	Wake	Day	Evng	Night
Setpoint Heat, °F	70	62	70	62	70	68	70	62	70	68	70	62
Setpoint Cool, °F	75	82	75	82	75	78	75	82	75	78	75	82
Time	6:00 AM	10:00 PM	8:00 AM	10:00 PM	6:00 AM	11:00 AM	1:00 PM	10:00 PM	8:00 AM	11:00 AM	1:00 PM	10:00 PM

**Table 11. Work Week Schedule with Separate Weekend Days - 2 Periods per Day.**

Day	Work Week (Monday-Friday)		Saturday		Sunday	
	Day	Night	Day	Night	Day	Night
Setpoint Heat, °F	70	62	70	62	70	62
Setpoint Cool, °F	75	82	75	82	75	82
Time	6:00 AM	10:00 PM	8:00 AM	10:00 PM	8:00 AM	10:00 PM

**NOTE:** Individual Days, periods per day: Parameter 107 = 3; Parameter 108 = 2; Parameter 109 = F

**Table 12. Work Week Schedule with Separate Weekend Days – 4 Periods Per Day.**

Phase	Work Week (Monday-Friday)				Saturday				Sunday			
	Wake	Day	Evng	Night	Wake	Day	Evng	Night	Wake	Day	Evng	Night
Setpoint Heat	70	68	70	62	70	68	70	62	70	68	70	62
Setpoint Cool	75	78	75	82	75	78	75	82	75	78	75	82
Time	6:00 AM	11:00 AM	1:00 PM	10:00 PM	8:00 AM	11:00 AM	1:00 PM	10:00 PM	8:00 AM	11:00 AM	1:00 PM	10:00 PM

**NOTE:** Parameter 107 = 3; Parameter 108 = 4; Parameter 109 = F

**Table 13. Individual Days (Monday – Sunday).**

Day	2 Periods Per Day		4 Periods Per Day			
	Day	Night	Wake	Day	Evng	Night
Setpoint Heat	70	62	70	62	70	62
Setpoint Cool	75	82	75	78	75	82
Time	6:00 AM	10:00 PM	6:00 AM	11:00 AM	1:00 PM	10:00 PM

**NOTE:** Daily Schedule – 2 periods per day: Parameter 107 = 7; Parameter 108 = 2; Parameter 109 = F  
 Daily Schedule – 4 periods per day: Parameter 107 = 7; Parameter 108 = 4; Parameter 109 = F

**Table 14. Suggested Sensors for Use with RDY2000.**

Siemens Part Number	Description	Signal Format
QAA2330.EWNN	Remote Wall-Mounted Sensor – Temperature Only	10K Ohm, Type II NTC
QFA33SS.EWNN	Remote Wall-Mounted Temperature and Humidity Sensor	0-10V
QAM2030.010	Duct-Mounted Temperature Sensor	10K Ohm, Type II NTC
QFM2160U	Duct-Mounted Temperature & Humidity Sensor	0-10V
QPA2000	Wall-Mounted CO2 Sensor	0-10V
QPA2062	Wall-Mounted Temperature + Humidity + CO2 Sensor	0-10V
QPM2162	Duct-Mounted Temperature + Humidity + CO2 Sensor	0-10V
QAC2030	Outdoor Air Temperature Sensor	10K Ohm, Type II NTC
QAD2030	Surface-Mount Pipe Temperature Sensor	10K Ohm, Type II NTC

### Federal Communications Commission Notice

This equipment has been tested and found to comply with the limits for a Class B digital device, pursuant to Part 15 of the FCC rules. These limits are designed to provide reasonable protection against harmful interference in a residential installation. This equipment generates, uses, and can radiate radio frequency energy and, if not installed and used in accordance with the instructions, may cause harmful interference to radio communications. However, there is no guarantee that interference will occur in a particular installation. If this equipment does cause harmful interference to radio or television reception, which can be determined by turning the equipment off and on, the user is encouraged to try to correct the interference by one or more of the following measures:

- Reorient or relocate the receiving antenna.
- Increase the separation between the equipment and the receiver.
- Connect the equipment into an outlet on a circuit different from that to which the receiver is connected.
- Consult the dealer or an experienced radio/TV technician for help.

### Modifications

This device complies with Part 15 of the FCC rules and IC rules. Changes or modifications not expressly approved by Siemens Industry Inc. could void the user's authority to operate the equipment.

### Industry Canada

This Class B digital apparatus meets all requirements of the Canadian Interference-Causing Equipment Regulations.

Cet appareil numérique de la classe B respecte toutes les exigences du Règlement sur le matériel brouilleur du Canada.  
 CAN ICES-3 (B)/NMB-3 (B)

### Limited Warranty

Siemens Product Guard Warranty warrants the purchased from it or its authorized reseller to be free from defects in material and workmanship under normal use during the two-year period commencing on the date of purchase. The written proof of purchase is required for such warranty period to apply.

The software included in this Siemens product is licensed for use subject to the Siemens end-user license agreement ("EULA") posted at [www.usa.siemens.com/btcpseula](http://www.usa.siemens.com/btcpseula) (Siemens' EULA web site) for this software identified by product model or part number on the Siemens EULA web site.

Information in this publication is based on current specifications. The company reserves the right to make changes in specifications and models as design improvements are introduced. Other product or company names mentioned herein may be the trademarks of their respective owners. © 2018 Siemens Industry, Inc.

**Table 15. Record Field Settings.**

Parameter	Definition	Default	Field Value
P101	System Type	CO	
P102	Cooling Stages	2	
P103	Heating Stages	2	
P104	Aux Heating Stages	0	
P105	Fan Operation	NO	
P106	Reversing Valve	O	
P107	Scheduler Days	2	
P108	Program Periods	2	
P110	Auto Change	YES	
P111	Changeover Deadband	5°F (2.5°C)	
P112	Daylight Savings	YES	
P201	Heat Temp Limit	95°F (35.0°C)	
P202	Cool Temp Limit	50°F (10.0°C)	
P203	Temperature Display Offset	0°F (0°C)	
P204	Override Time Limit	---	
P205	Override Temp Limit	---	
P206	Heat Pump Compressor Lock Out	OFF	
P207	Heat Pump Auxiliary Heat Lockout	OFF	
P208	Service UV Lamp	0	
P209	Service Humidifier	0	
P210	Service Air Filter	0	
P211	Keypad Lockout	0	
P213	Backlight	15	
P301	Configurable Input 1 (IN1)	0	
P302	Temperature Input 1 Type	0	
P303	Temperature Input 1 Low	0°F (-18.0°C)	
P304	Temperature Input 1 High	120°F (50°C)	
P305	Configurable Input 2 (IN2)	0	
P306	Temperature Input 2 Type	0	
P307	Temperature Input 2 Low	0°F (-18.0°C)	
P308	Temperature Input 2 High	120°F (50.0°C)	
P309	Configurable Input 3 (IN3)	0	
P310	Temperature Input 3 Type	0	
P311	Temperature Input 3 Low	0°F (-18.0°C)	
P312	Temperature Input 3 High	120°F (50.0°C)	
P313	Configurable Input 4 (IN4)	0	
P314	Temperature Input 4 Type	0	
P315	Temperature Input 4 Low	0°F (-18.0°C)	
P316	Temperature Input 4 High	120°F (50.0°C)	
P317	Aux Output 1 (OUT1)	0	
P318	Aux Output 2 (OUT2)	0	
P319	Aux Output 3 (OUT3 & C3)	0	
P320	Independent Humidity Control	No	
P401	Unit Number	---	
P402	CO2 Setpoint	800	
P403	Pre-Occupancy Purge	0	
P404	Occupancy Sensor Min Run Timer	30	
P405	Semi-Continuous Fan	NO	
P407	Installer Password	0000	
P701	Firmware Revision	N/A	
P501	Stage Delay - Cooling	2	
P502	Stage Differential - Cooling	1°F (0.5°C)	
P503	Cooling Minimum Off Time	5	
P504	Cooling Minimum On Time	3	
P505	Changeover Delay	10	
P506	Cooling Deadband	1°F	
P507	Stage Delay - Heating	2	
P508	Stage Differential - Heating	Conv. = 1°F (0.5°C); HP = 2°F (1°C)	
P509	Heating Minimum Off Time	5	
P510	Heating Minimum On Time	5 (10 if heat pump)	
P511	Heating Deadband	1°F (0.5°C)	
P911	Expert Password	99:99	