



Outside Sensors QAC... FW-T1G

- Passive sensors for acquiring the outside temperature and – to a lesser degree – solar radiation, the wind effect and the temperature of the wall.
- Range of use $-40/50...+70\text{ °C}$ / $5...95\text{ % r. F.}$

Use

The QAC... outside sensors are for use in heating, ventilation and air conditioning plants as:

- Reference sensors for weather-compensated control
- Measuring sensors, e.g. for optimization, measured value indication, or for connection to a building automation and control system

Type summary

Type reference	Sensing element	Range of use	Time constant	Approval
QAC22	LG-Ni 1000	$-50...+70\text{ °C}$	ca. 14 min	
QAC32	NTC 575 (linearized)	$-50...+70\text{ °C}$	ca. 12 min	
QAC2010	Pt 100	$-50...+70\text{ °C}$	ca. 14 min	UL, class 2
QAC2012	Pt 1000	$-50...+70\text{ °C}$	ca. 14 min	UL, class 2
QAC2030	NTC10k	$-40...+70\text{ °C}$	ca. 14 min	UL, class 2
FW-T1G^{*)}	T1 (PTC)	$-50...+70\text{ °C}$	ca. 14 min	

*) No longer available

Ordering and delivery

When ordering, please give name and type reference, e.g.:
Outside sensor **QAC22**.

Equipment combinations

The outside sensors are suited for use with all types of controllers capable of acquiring and handling the sensor's measured value.

Function

The outside sensor acquires the outside temperature and – to a lesser degree – solar radiation, the wind effect and the temperature of the wall. The sensing element changes its resistance value as a function of the temperature.

Sensing elements

LG-Ni 1000

Characteristic:

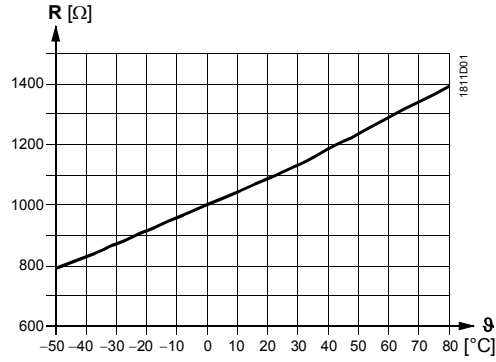

Accuracy:

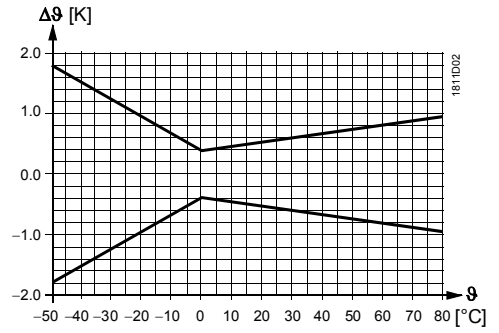

NTC 575

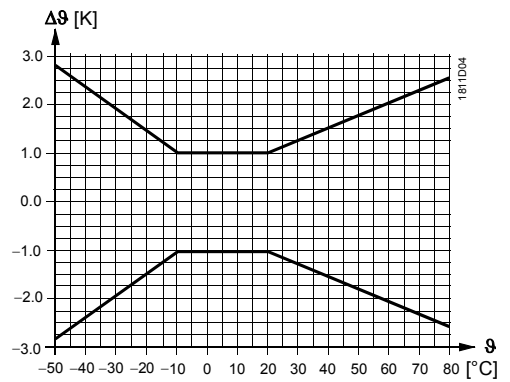
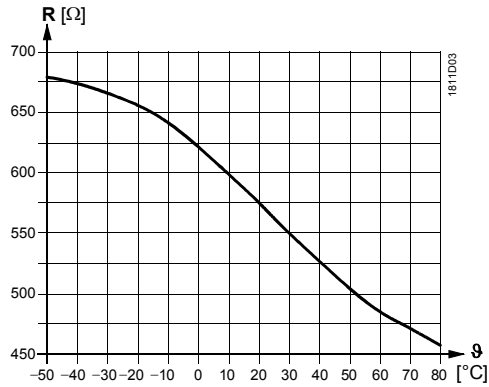

Pt 100 (class B)

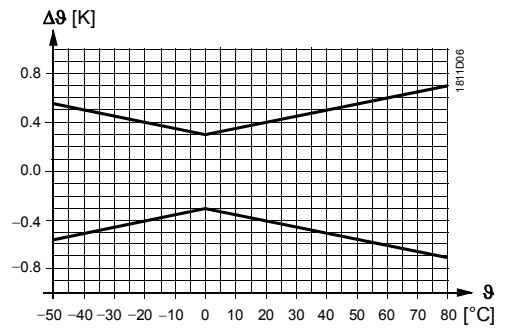
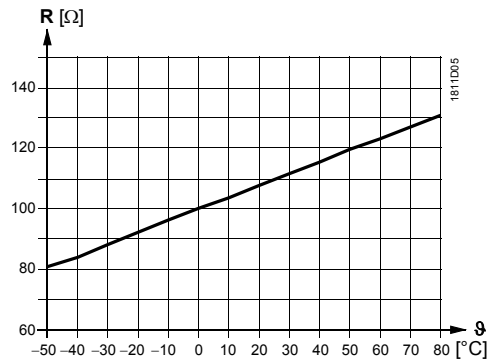

Pt 1000 (class B)

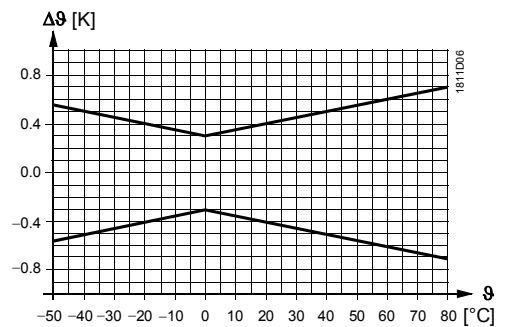
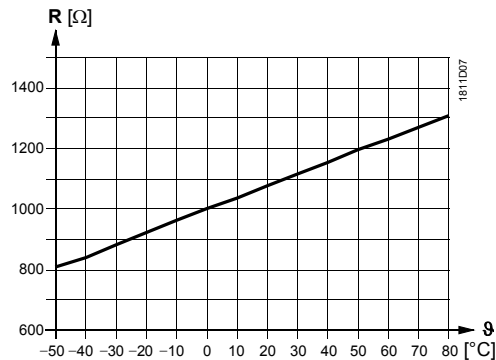

NTC 10k

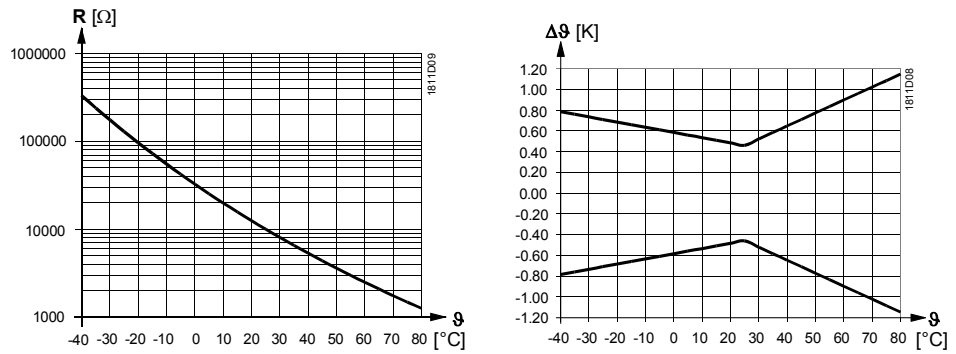

T1 (PTC)

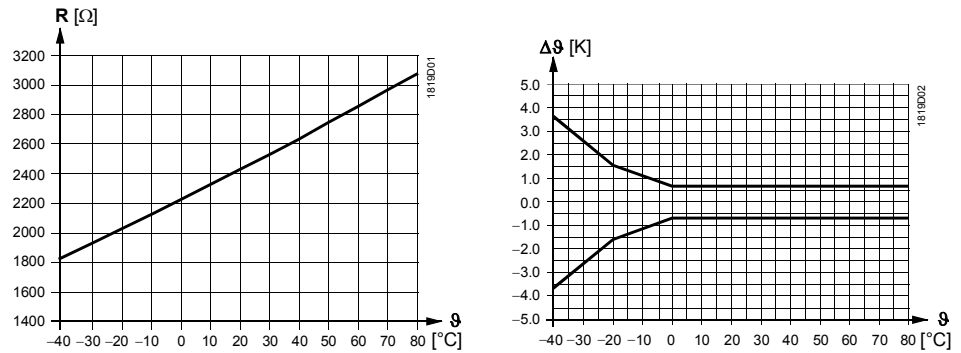

Legend

R	Resistance in Ohm
θ	Temperature in degrees Celsius
$\Delta\theta$	Temperature differential in Kelvin

Mechanical design

The sensor has a plastic housing with a removable cover.
The connection terminals can be accessed after removal of the cover.
Cable entry is either from the rear (concealed wiring) or from below (surface-run wires).
A cable entry gland can be screwed into the bottom of the housing.

Engineering notes

The permissible cable lengths depend on the type of controller with which the sensor is used. They are specified in the Data Sheet of the relevant controller.

Mounting notes

Depending on use, the outside sensor must be located as follows:

Mounting location

- For control:
On the wall of the house or building that has the windows of the occupied rooms, but the sensor must not be exposed to the morning sun. In case of doubt, it should be mounted on the wall facing north or north-west
- For optimization:
Always on the coldest wall of the house or building (normally the wall facing north).
The sensor must never be exposed to the morning sun

Mounting height

Preferably in the middle of the house or building or heating zone, but at least 2.5 m above the ground.

The sensor must **not** be fitted at the following locations:

- Above windows, doors, air extracts or other heat sources
- Below balconies or the eave of the roof

To prevent measuring errors due to air circulation, the cable conduit at the sensor should be sealed.

The sensor may not be painted over.

Mounting Instructions are printed on the packaging.

Disposal



The device is considered electrical and electronic equipment for disposal in terms of the applicable European Directive and may not be disposed of as domestic garbage.

- Dispose of the device via the channels provided for this purpose.
- Comply with all local and currently applicable laws and regulations.

Technical data

Functional data	Range of use	refer to "Type summary"
	Sensing element	refer to "Type summary"
	Time constant	refer to "Type summary"
	Accuracy	refer to "Function"
	Type of measurement and output	passive
Degree of protection	Protection class	III according to EN 60730
	Protection degree of housing	IP54 according to EN 60529
Electrical connections	Screw terminals for	2 x 1.5 mm ² or 1 x 2.5 mm ²
	Cable entry for	cable gland (e.g. M 16 x 1.5)
	Perm. cable length	refer to "Engineering notes"
Environmental conditions	Operation	
	Climatic conditions	
	Temperature	-40...+70 °C
	Humidity	0...100 % r. h.
	Storage / transport to	IEC 721-3-2
	Climatic conditions	class 2K3
Temperature	-25...+65 °C	
Humidity	<95 % r. h.	
Mechanical conditions	class 2M2	
Directives and Standards	Product standard	EN 60730-1 Automatic electrical controls for household and similar use
	EU conformity (CE)	8000073890 *)
	UL	UL873 http://ul.com/database
Environmental compatibility	The product environmental declaration CE1E1701 ¹⁾ contains data on environmentally compatible product design and assessments (RoHS compliance, materials composition, packaging, environmental benefit, disposal).	
Materials and colors	Base	plastic (ASA)
	Cover	plastic (ASA), RAL9003
	Packaging	cardboard
Weight	Incl. packaging	approx. 0.093 kg

*) The documents can be downloaded from <http://siemens.com/bt/download>.

Internal diagram

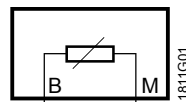

The internal diagram is identical for all types of outside sensors covered by this Data Sheet.

The connecting wires are interchangeable.

Dimensions

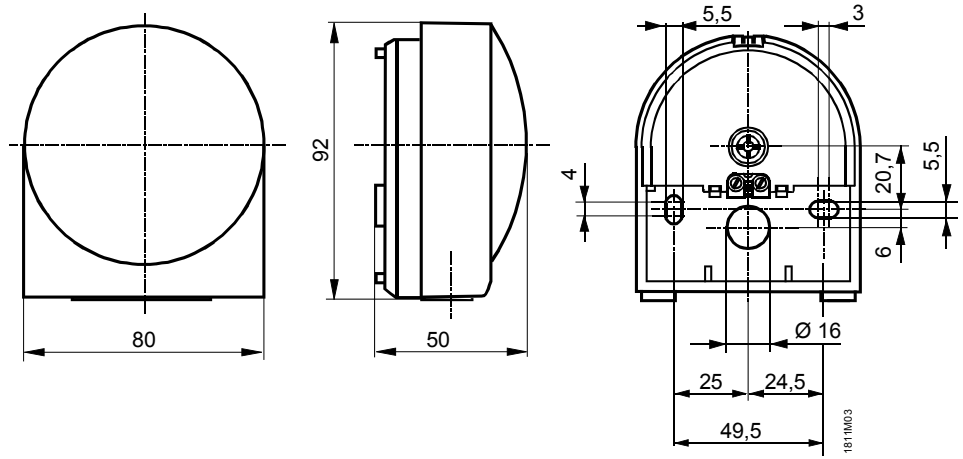

Dimension in mm

Drilling plan

Published by:
Siemens Switzerland Ltd.
Building Technologies Division
International Headquarters
Gubelstrasse 22
6301 Zug
Switzerland
Tel. +41 58-724 24 24
www.siemens.com/buildingtechnologies

© Siemens Switzerland Ltd 2014
Delivery and technical specifications subject to change