

Powermite 599 Series

MT Series Terminal Unit Three-way Valves

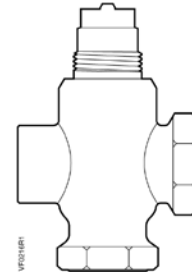

Description The Powermite Series ANSI Class 250 MT Series three-way valves are designed to work with any MT Series pneumatic or electronic actuator with a 7/32 inch (5.5 mm) stroke.

- Features**
- Direct coupled universal bonnet
 - Choice of brass or stainless steel trim
 - ANSI Leakage Class IV (0.01% of Cv)

Application A typical application for the Powermite three-way valve is the mixing of hot or chilled water for convectors, fan coil units, unit conditioners, radiation, reheat coils, and similar terminal units requiring an actuator that delivers a minimum of 67 pounds force (300N).

Ordering a Valve Plus Actuator Assembly To order a complete valve plus actuator assembly from the factory, combine the actuator prefix code with the suffix of the valve assembly product number. See *Technical Bulletin (TB) 251*, (155-306P25) for selection procedure and ordering codes.

Valve assemblies can be ordered using the numbers in Table 1.

Product Numbers

Table 1. Product Numbers.

Flow Rate		Valve size		Product Number	
Cv	(Kvs)	Inch	(mm)	Brass Trim	Stainless Steel Trim
0.4	(0.34)	1/2	(15)	599-02064	599-02072
0.63	(0.54)	1/2	(15)	599-02065	599-02073
1.0	(0.85)	1/2	(15)	599-02066	599-02074
1.6	(1.37)	1/2	(15)	599-02067	599-02075
2.5	(2.15)	1/2	(15)	599-02068	599-02076
4.0	(3.44)	1/2	(15)	599-02069	599-02077
6.3	(5.43)	3/4	(20)	599-02070	599-02078
10	(8.6)	1	(25)	599-02071	599-02079

Specifications

	Valve size	1/2 inch to 1 inch (15 to 25 mm)
	Capacity	See Tables 3 and 4 and Figure 1
	Body style	Globe
	Seat style	Metal-to-metal
	Action	3-way mixing
	Valve body rating	ANSI Class 250; See Table 2
	Stem travel (Stroke)	7/32-inch (5.5 mm)
Material	Body	
	1/2- and 3/4-inch	C37700 Forged brass
	1-inch	UNS CA 844 Bronze
	Body trim	See Table 1
	Stem	Stainless steel ASTM A582 Type 303
	Packing	Ethylene propylene O-ring
Operating	Spring Range	8-13 psi (55 to 90 kPa)
	Controlled medium	Water, glycol solutions to 50%
	Medium temperature range	35°F to 250°F (2°C to 120°C)
	Maximum inlet pressure	See Table 2
	Maximum recommended differential pressure for modulating service	
	Brass trim	25 psi (173 kPa)
	Stainless steel trim	50 psi (345 kPa)
	Rangeability	
	Cv <1	>50:1
	Cv >1	>100:1
	Close-off pressures	See Tables 5 and 6 and Figure 2
	Close-off ratings	According to ANSI/FCI 70-2
Leakage rate	Class IV (0.01% of Cv)	
Flow characteristics	Linear	
Miscellaneous	Canadian Registration Numbers	0H7645.5 0C0838.9
	Mounting location	NEMA 1 (interior only)
	Dimensions	See Tables 7 and 8 and Figures 4 and 5
	Valve weight	See Table 7
Service Kit	Protective black knob to cover the bonnet and threads/manual override	 426888950

Table 2. Body Temperature-Pressure Rating.

Valve Body	Temperature		Pressure	
	°F	°C	psig	(kPa)
Bronze/ Forged Brass	-20 to 150	-30 to 66	400	(2758)
	200	93	385	(2655)
	250	121	365	(2586)
	300	149	335	(2300)
	350	177	300	(2068)

Table 3. Maximum Water Capacity - U.S. Gallons per Minute.

Valve Size inches	Pressure Differential - psi															
	Cv\1	2	3	4	5	6	8	10	15	20	25	30	40	50	60	75
1/2	0.4	0.6	0.7	0.8	0.9	1.0	1.1	1.3	1.5	1.8	2.0	2.2	2.5	2.8	3.1	3.5
	0.63	0.9	1.1	1.3	1.4	1.5	1.8	2.0	2.4	2.8	3.2	3.5	4.0	4.5	4.9	5.5
	1.0	1.4	1.7	2.0	2.2	2.5	2.8	3.2	3.9	4.5	5.0	5.5	6.3	7.1	7.8	8.7
	1.6	2.3	2.8	3.2	3.6	3.9	4.5	5.1	6.2	7.2	8.0	8.8	10.1	11.3	12.4	13.9
	2.5	3.5	4.3	5.0	5.6	6.1	7.1	7.9	9.7	11.2	12.5	13.7	15.8	17.7	19.4	22
	4	5.7	7	8.0	8.9	10	11.3	12.6	15.5	17.9	20.0	21.9	25	28	31	35
3/4	6.3	8.9	10.9	12.6	14.1	15.4	17.8	20	24	28	32	35	40	45	49	55
1	10	14.1	17.3	20	22	24	28	32	39	45	50	55	63	71	77	87

Table 4. Maximum Water Capacity - Cubic Meters per Hour (m³/hr).

Valve Size inch (mm)	Pressure Differential - kPa														
	1	10	20	30	40	50	60	80	Kvs/100	150	200	300	400	500	
15	0.03	0.11	0.15	0.19	0.22	0.24	0.26	0.30	0.34	0.42	0.48	0.59	0.68	0.76	
	0.05	0.17	0.24	0.30	0.34	0.38	0.42	0.48	0.54	0.66	0.76	0.94	1.08	1.21	
	0.09	0.27	0.38	0.47	0.54	0.60	0.66	0.76	0.85	1.0	1.2	1.5	1.7	1.9	
	0.14	0.43	0.61	0.75	0.87	0.97	1.06	1.23	1.37	1.7	1.9	2.4	2.7	3.1	
	0.21	0.68	0.96	1.17	1.35	1.51	1.66	1.91	2.15	2.6	3.0	3.7	4.3	4.8	
	0.34	1.1	1.5	1.9	2.2	2.4	2.7	3.1	3.4	4.2	4.9	6.0	6.9	7.7	
20	0.54	1.7	2.4	3.0	3.4	3.8	4.2	4.9	5.4	6.7	7.7	9.4	10.9	12.1	
25	0.86	2.7	3.8	4.7	5.4	6.1	6.7	7.7	8.6	10.5	12.2	14.9	17.2	19.2	

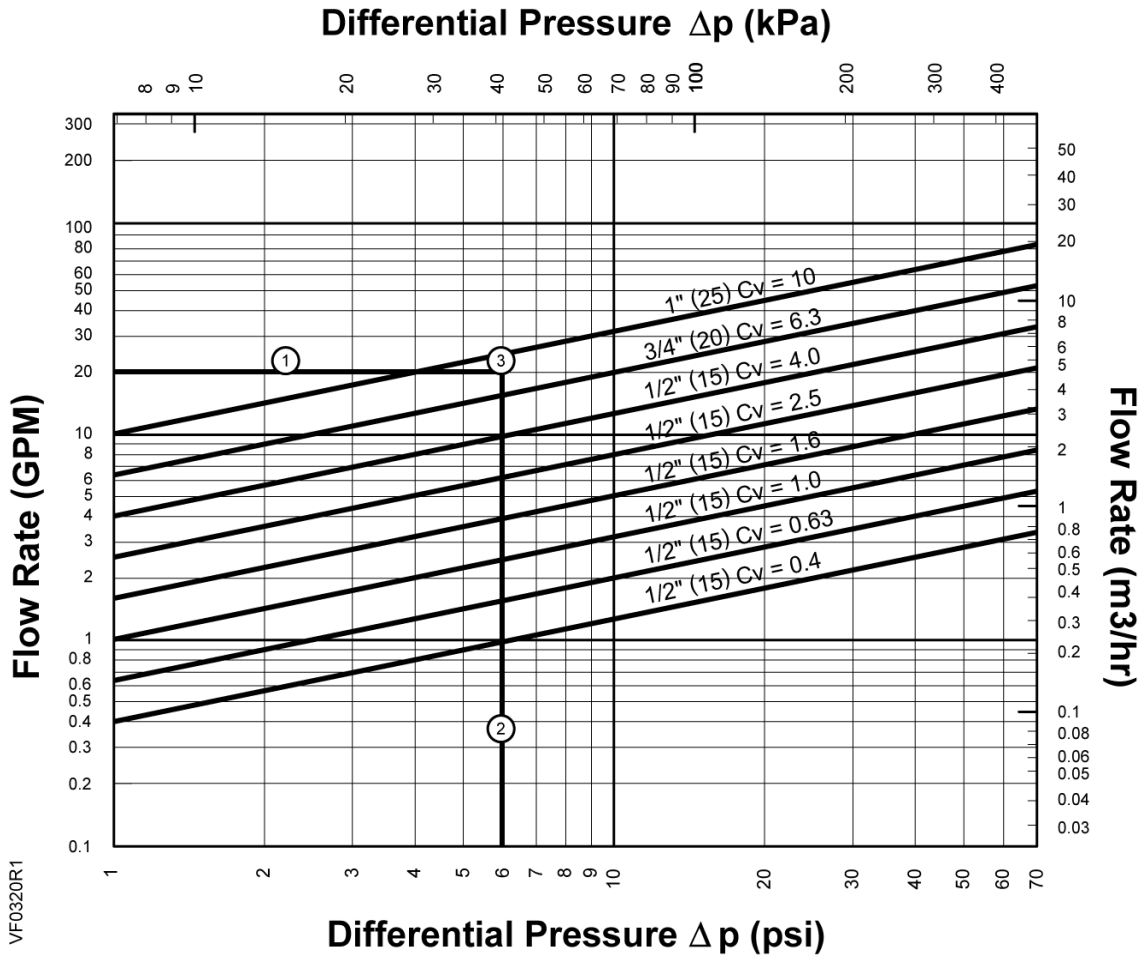

Figure 1. Water Capacity Graph.

Selection Example

Select a valve given:

See Figure 1.

- ① Required flow = 20 gpm.
- ② Desired pressure drop = 5 psi.
- ③ Choose a 1-inch (25-mm) valve, Cv 10.

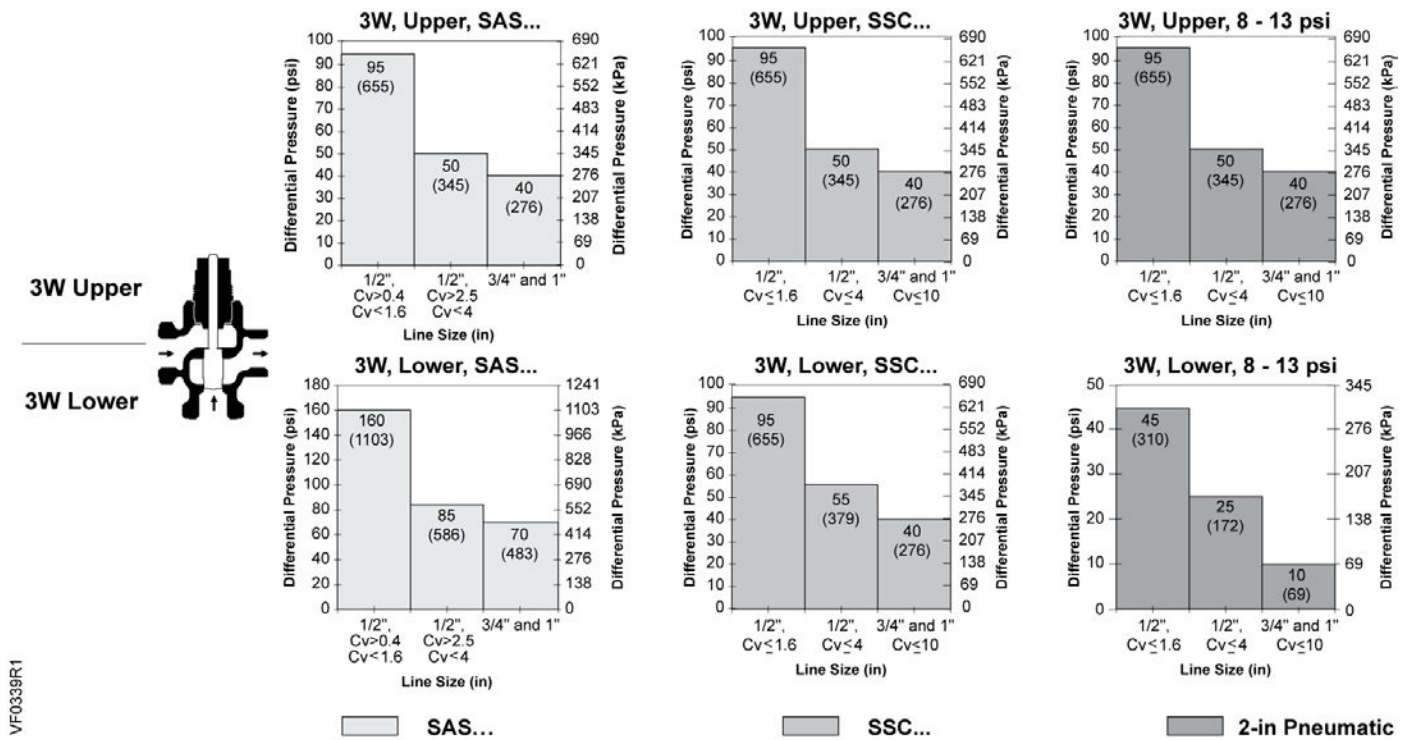

Figure 2. Close-off Pressures.

Table 5. Close-off Pressures for Electronic Actuators.

Action 3-Way	Valve Size Inches (mm)	SAS psi (kPa)	SSC psi (kPa)
NC Upper Port	1/2 0.4 < Cv < 1.6 (15) (0.34 < Kvs < 1.37)	95 (655)	95 (655)
	1/2 2.5 < Cv < 4 (15) (2.15 < Kvs < 3.44)	50 (345)	50 (345)
	3/4 (20)	40 (276)	40 (276)
	1 (25)		
NO Bottom Port	1 (25)	10 (69)	10 (69)
	1/2 0.4 < Cv < 1.6 (15) (0.34 < Kvs < 1.37)	160 (1103)	95 (655)
	1/2 2.5 < Cv < 4 (15) (2.15 < Kvs < 3.44)	85 (586)	55 (379)
	3/4 (20)	70 (482)	40 (276)
1 (25)			

Table 6. Maximum Available Close-off Pressures for Pneumatic Actuators.

Action 3-Way	Valve Size Inches (mm)	2-inch Actuator 0 psi (0 kPa) (with 8 to 13 psi Valve)
NC Upper Port	1/2 0.4 < Cv < 1.6 (15) (0.34 < Kvs < 1.37)	95 (655)
	1/2 2.5 < Cv < 4 (15) (2.15 < Kvs < 3.44)	50 (345)
	3/4 (20)	40 (276)
	1 (25)	
		15 psi (103 kPa) (with 8 to 13 psi Valve)
NO Bottom Port	1/2 0.4 < Cv < 1.6 (15) (0.34 < Kvs < 1.37)	45 (310)
	1/2 2.5 < Cv < 4 (15) (2.15 < Kvs < 3.44)	25 (172)
	3/4 (20)	10 (69)
	1 (25)	

Operation

As the valve stem moves downward, the flow through the NO port decreases and the flow through the NC port increases. As the valve stem moves upward, the flow through the NO port increases and the flow through the NC port decreases.

In the event of power failure, a spring return actuator returns the valve to its normal position. Non-spring return actuators will hold the last commanded position. See the Technical Instructions of the various actuators for additional information.

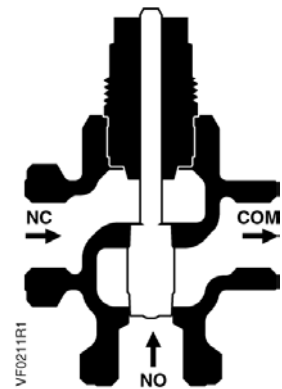

Figure 3.

Sizing

The sizing of a valve is important for correct system operation. An undersized valve will not have sufficient capacity at maximum load. An oversized valve can initiate cycling, and the seat and throttling plug can be damaged because of the restricted opening. Correct sizing of the control valve for actual expected conditions is considered essential for good control.

The following variables must be determined:

The medium to be controlled: water, and so on.

The maximum inlet temperature and pressure of the medium at the valve.

The pressure differential that will exist across the valve under maximum load demand.

The maximum capacity the valve must deliver.

The maximum line pressure differential the valve actuator must close against.

See *Application Bulletin (AB)-1 Control Valve Selection and Sizing (155-285)* for further recommendations.

See Tables 3 and 4 for valve capacities.

Mounting and Installation

Install the valve so that the flow follows the direction of the arrow indicated on the valve body.

For best performance, install the valve assembly with the actuator above the valve body. The valve and actuator can be installed in any position between vertical and horizontal. It is not recommended to install the valve assembly so that the actuator is below horizontal or upside down.

Allow sufficient space for servicing the valve and actuator. See Table 7 for valve body dimensions. See Figure 5 and Table 8 for dimensions of the service envelope recommended around the actuator.

NOTE: Instructions for field mounting an actuator, wiring diagrams, and start-up are covered in the Technical Instructions and Installation Instructions for each actuator.

Service

Replace the valve if inoperable.

Dimensions

See Table 7 for valve body dimensions. The letters in Figure 5 refer to the valve centerline to top of actuator, width of the actuator, and service envelope dimensions in Table 8.

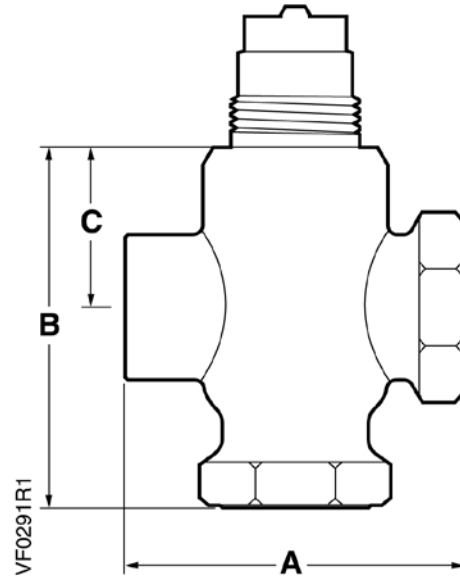

Figure 4. 3-Way Valve Body.

Table 7. 3-Way Valve Dimensions.

Valve Size Inches (mm)	A	B	C	Weight Pounds (kg)
1/2 (15)	2-3/4 (70)	2-15/16 (74)	1-5/16 (33)	1.10 (0.5)
3/4 (20)	3-1/4 (83)	3-9/16 (90)	1-5/16 (33)	1.44 (0.65)
1 (25)	3-7/8 (98)	3-15/16 (99)	1-9/16 (39)	2.20 (1.0)

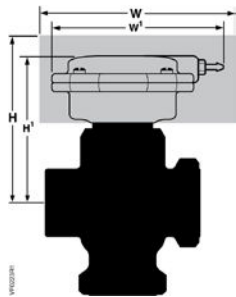

Figure 5.

Table 8. Dimensions of the Actuators and Recommended Service Envelope.
Dimensions in Inches (Millimeters).

Actuator	Actuator Prefix Code	Valve size	Centerline to Top of Actuator, H1	Service Height, H	Width or Diameter of Actuator, W1	Service Width, W
599-01088 2-Inch Pneumatic	256, 257, 258	1/2 (15)	3-1/16 (78)	11 (280)	4 (100)	10 (250)
		3/4 (20)	3-1/16 (78)	11 (280)	4 (100)	10 (250)
		1 (25)	3-5/16 (84)	11-1/4 (285)	4 (100)	10 (250)
SAS NSR	363 364	1/2 (15)	7-1/2 (191)	15-1/2 (394)	3-1/2 (89)	7-1/2 (191)
		3/4 (20)	7-1/2 (191)	15-1/2 (394)	3-1/2 (89)	7-1/2 (191)
		1 (25)	7-3/4 (197)	15-3/4 (400)	3-1/2 (89)	7-1/2 (191)
SAS SR	365 366	1/2 (15)	7-1/2 (191)	15-1/2 (394)	4 (100)	8 (203)
		3/4 (20)	7-1/2 (191)	15-1/2 (394)	4 (100)	8 (203)
		1 (25)	7-3/4 (197)	15-3/4 (400)	4 (100)	8 (203)
SSC	259 260 261 262	1/2 (15)	5-1/2 (140)	13-1/2 (343)	4-3/4 (121)	12-3/4 (324)
		3/4 (20)	5-1/2 (140)	13-1/2 (343)	4-3/4 (121)	12-3/4 (324)
		1 (25)	5-3/4 (146)	13-3/4 (349)	4-3/4 (121)	12-3/4 (324)

Parts of the Valve

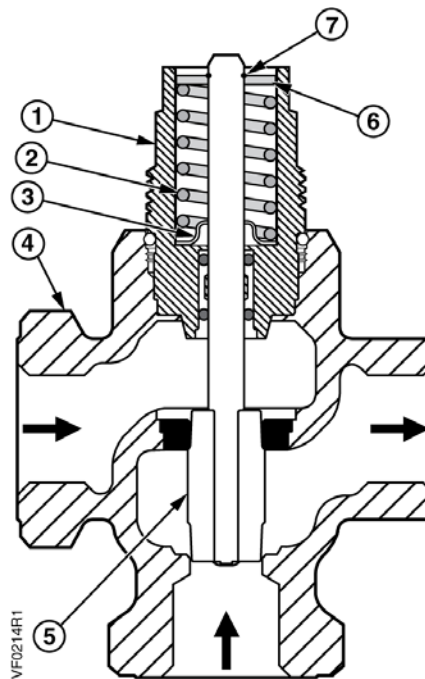

Table 9. 3-Way Bronze/Forged Brass Valves.

Item	Part Name	Part No.	Qty	Material
1	Bonnet Assembly	—	1	—
2	Spring	—	1	Stainless steel
3	Wiper	—	1	Nylon
4	Valve Body	—	1	Bronze/Forged Brass
5	Stem and Plug Assembly	—	1	Stainless steel or brass
6	Upper guide disc	—	1	Brass
7	Retaining ring	—	1	Stainless steel

Information in this publication is based on current specifications. The company reserves the right to make changes in specifications and models as design improvements are introduced. Product or company names mentioned herein may be the trademarks of their respective owners.
 © 2015 Siemens Industry, Inc.